

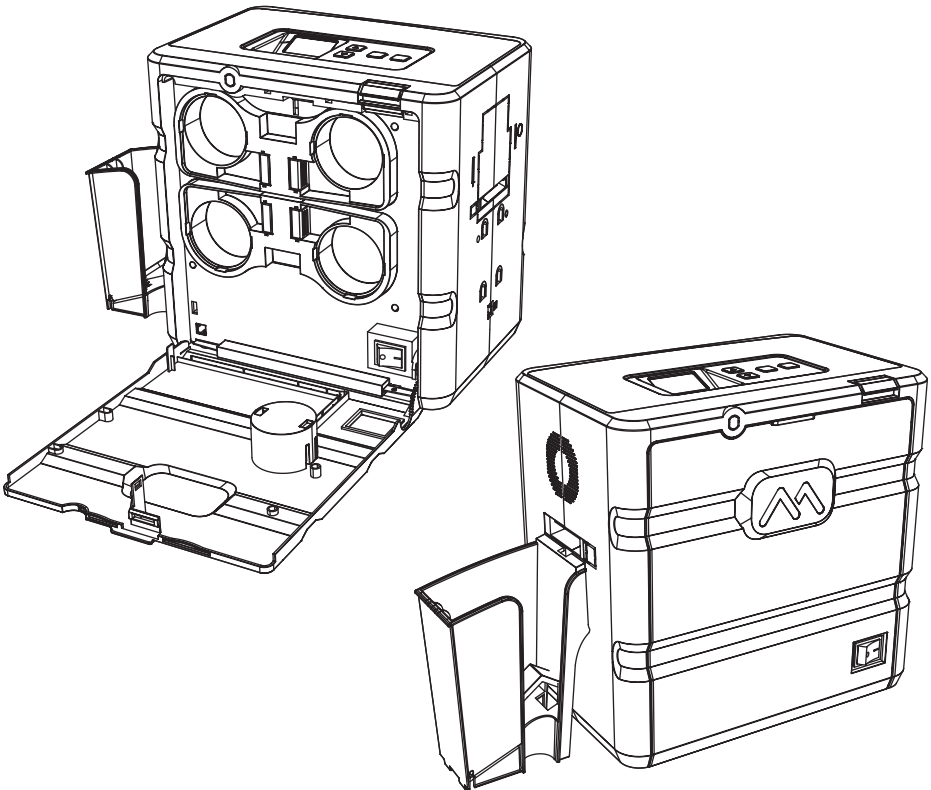

MC-L2 Lamination Unit



Contents

Safety Precautions	05
Getting Started	08
Product Overview	08
In the Box	09
Names of Parts	10
MC-L2 (Dual-sided Laminate)	10
MC-L2/IN/UC (Upper Single-sided Laminate)	12
MC-L2/IN/LC (Lower Single-sided Laminate)	14
Open Front Cover	16
Close Front Cover	17
Load Upper Cleaning Roller & Films	18
Load Upper Cleaning Roller	18
Load Films to Upper Cartridge	20
Load Lower Cleaning Roller & Films	22
Load Lower Cleaning Roller	22
Load Films to Lower Cartridge	24
Load/Unload Card Stacker to Laminator	26
Load Card Stacker to Laminator	26
Remove Cards after Taking Out Card Stacker	26
Remove Cards without Taking Out Card Stacker	27
Connect Power & Communication Cables	28
Connect Power Cable	28
Connect Communication Cable	28

Power On	-----	29
Front Cover Lock	-----	30
Button Control & Menu	-----	31
Buttons	-----	31
Description on Laminator Status on LCD	-----	31
Laminate side setting (Pass Mode)	-----	32
Lamination Temperature (Temper_set)	-----	35
Film Position (Start POS set)	-----	37
Power Saving Mode	-----	39
Path Sensor	-----	41
Serial No. (Product_infor)	-----	44
Factory Reset (Factory init)	-----	46
Card issuance and cancel	-----	51
Maintenance Instructions	-----	53
Supported Cards	-----	53
① Size	-----	53
② Thickness	-----	53
③ Acceptable Cards	-----	53
④ Unacceptable Cards	-----	53
Clean the Laminator	-----	54
Clean the Exterior	-----	54
Clean Roller Using Cleaning Card	-----	54
Clean the Blue Cleaning Roller	-----	57
Troubleshooting	-----	58
Error Messages & Solutions	-----	58
Remove Jammed Card	-----	59

Film Specifications	-----60
Patch-Type Film	-----60
Laminator Specifications	-----61
Features	-----61
Standard Specifications	-----61
① Laminating Type	-----61
② Laminating Function	-----61
③ Laminating Speed	-----61
④ Laminating Temperature	-----61
⑤ Operating Temperature	-----61
⑥ Supported Card Size	-----61
⑦ Film Patch Dimensions	-----62
⑧ Film Patch Capacity	-----62
Optional Specifications	-----62
Laminator Specifications	-----62
① Product Dimensions (Width X Length X Height) and Weight	---62
1) MC-L2 (Standard)	-----62
2) MC-L2 (Standard, Card Stacker)	-----62
② Power Supply	-----62
③ Interface	-----62
Regulatory	-----64

Safety Precautions

Before using or maintaining the product, please read this manual carefully.

Not following the instructions included in this manual may result in fire and injuries such as electric shocks and burns. To prevent any damage to product or person, please read and follow the safety instructions and keep this manual handy for future reference.

We are not responsible for any injuries or damages when the product is not used in compliance with these precautions.

-Symbols used in this manual

Please follow the safety instructions indicated as Warning, Caution, Important, Note, Prohibition, Electrical Hazard, Fire Hazard and High Temperature.

Check the following symbols used for easy understanding:



Warning

These warnings must always be followed; otherwise, this may result in serious injury or damage.



Caution

Not following this warning can cause service interruption or product damage.



Important

Use this information to check and inspect for the proper operation of the product.



Note

This is a note that provides more details or information that is useful for users.



Prohibition

Indicate a hazardous action which must be avoided at all times.



Electrical Hazard

Indicates a potentially hazardous situation which may result in electric shock.











Fire Hazard

Indicates a potentially hazardous situation which may result in fire.





High Temperature







Indicates a warning about high temperatures.

Power	
	Do not use a damaged plug or loose outlet.
	Do not pull the cable to unplug or touch the plug with wet hands.
	Do not bend the cable by force or place any heavy objects on it.
	Keep unplugged if not in use for an extended period of time or in case of lightening or thunder.
	Check whether the power cable is plugged into the outlet completely.
	The product must be used with AC power with rated label. Please contact us or authorized service representative if you require any assistance.
	Do not use the product if the power cable is damaged as it may result in electric shock or fire.
	If the product is exposed to rain or liquid, please turn off and unplug the cable, and contact an authorized service representative.







Operation/Handling	
	The surface of the product may be very hot right after using it. Please leave it for at least 15 minutes before making any contact.

Cleaning	
	Keep the power plug clean, away from dust and water.
	Unplug when cleaning, and do not spray water or use benzene or thinner.

Installation/Storage

	Do not install the printer in a place where it may be subjected to moisture, dust, or splashes of water (rain).
	Keep the printer away from heat sources, as well as lit candles and cigarettes.
	Keep any flammable liquid, gas, and aerosol away from the printer.
	Do not place the product where its vent can be blocked or interrupted.
	Do not block the air vent on the product as it can cause overheating or fire.
	Do not install the product as a built-in unit in a place with poor ventilation.
	Make sure that the power cable is properly arranged for your safety.
	Do not place the printer in direct sunlight as it may cause a malfunction.
	Do not place the product on the surface that is not stable (e.g. bed, sofa).
 	Make sure that the product is unplugged when installing it. (The cable may be damaged and cause fire or electric shock.)
 	In regular use product location (*Prevention of use when tilted or lay a product on the side)

Misc.

	Do not place metal objects, chemicals, or anything with water on it.
	If you observe smoke, odor, or noise from the Lamination Module, unplug it immediately and contact your dealer.
	Do not disassemble, repair, or modify the Lamination Module arbitrarily
	Do not remove any cover or protective device that is attached with screws.
	Do not operate the Lamination Module while your hand is placed inside.
	Clean and maintain the Lamination Module according to the instructions

Getting Started

-Product Overview

MC-L2 Lamination Module is designed to laminate PVC Cards to meet your specifications by applying laminate films to both sides of PVC Cards using a halogen heating system to prevent duplication by offering clear/holographic laminates to high security custom laminates. The MC-L2 can create membership cards, employee identification cards and access control security cards.

The MC-L2 features comfortable cassette loading of the consumables for single and dual sided usage, mechanical locks prevent unauthorized access of the lamination consumables.

The MC-L2 also comes with a 4 Line display panel which shows a step by step process of the lamination so end users have an easy out of box user experience. The MC-L2 supports 0.76mm(30mil) to 1.0mm(40mil) CR-80 Cards.

-In the Box

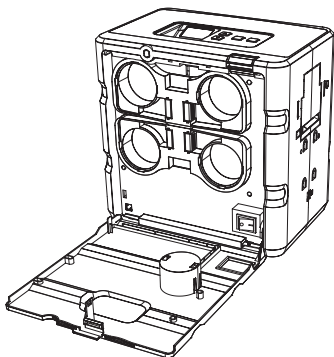

MC-L2
(Dual-sided Laminate)

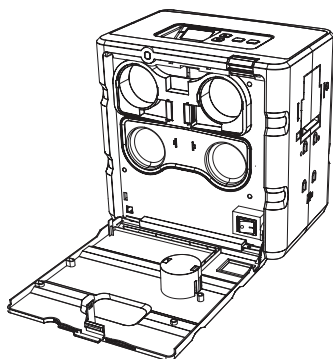

MC-L2
(Upper Single-sided Laminate)

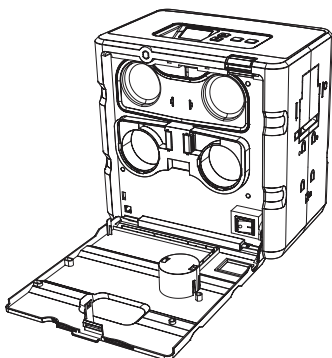

MC-L2
(Lower Single-sided Laminate)

Basic accessories

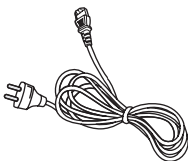

AC Power Cable

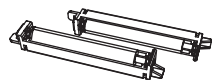

Cleaning Roller

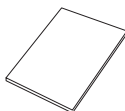

Getting Started Guide

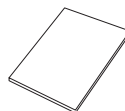

User Manual

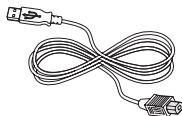

USB Cable



Stacker



Important

Please make sure that all the components and accessories are included in the box. If there are any missing or damaged items, then please contact your dealer for assistance.

Names of Parts

-MC-L2 (Dual-sided Laminate)

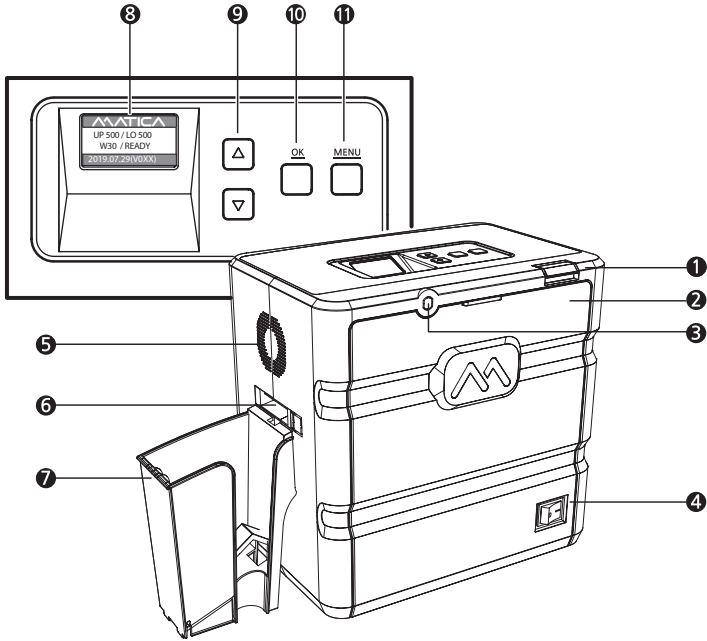

Name	Description
1 Front Cover Button	Opens the Front Cover.
2 Front Cover	Opens the cover to replace the Film and Cleaning Roller.
OPTION 3 Front Cover Lock	The Front Cover can be locked to protect the Film and other parts inside.
4 Power Switch	Turns the laminator on/off.
5 Fan Vent	Circulates air through the vent.
6 Card Ejector	Releases the laminated cards.
7 Card Stacker	Stacks the laminated cards. (max. 150 cards)
8 LCD Display	Displays the system status.
9 Menu Navigation Buttons	Used to navigate the menu or to cancel the lamination during the issuance.
10 OK Button	Used to confirm your choice on the menu or to issue the card.
11 Menu Button	Used to enter or exit the menu. (press once: enter, press once on the menu: exit)

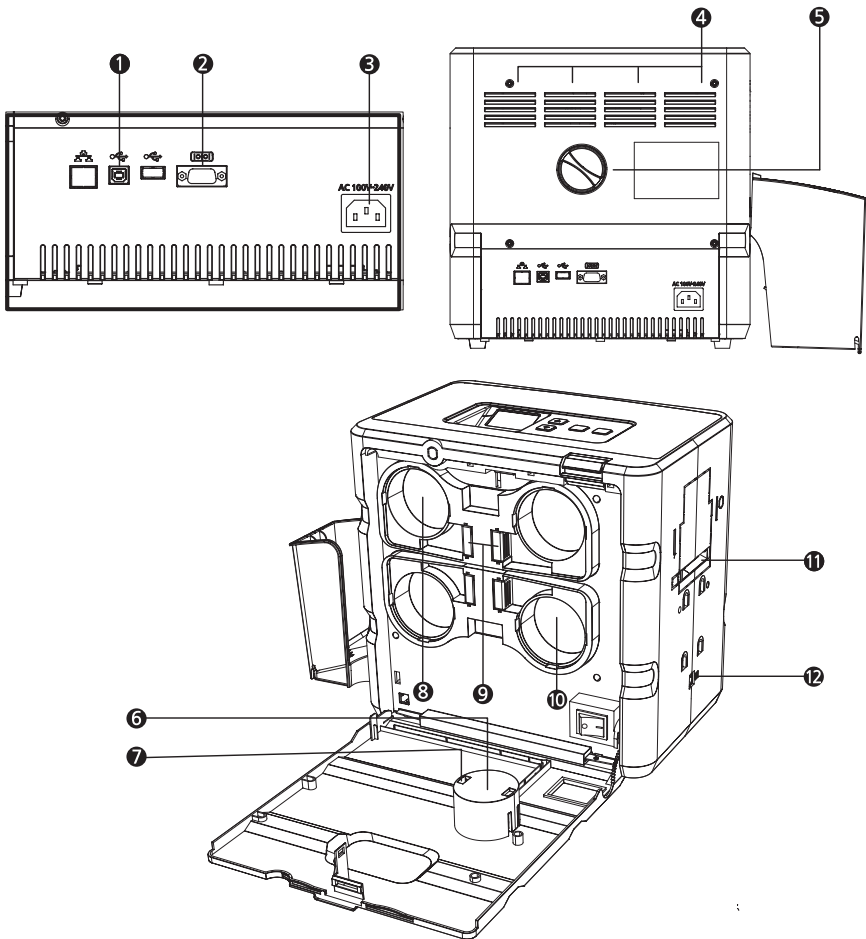

Name	Description
① USB Port	Used to connect the laminator and other devices using the USB cable.
② RS232C Port	Used to connect the laminator and other devices using the RS232C cable.
③ AC Power Port	Supplies power to the laminator using the AC power cable.
④ Air Vent	Circulates air to keep the temperature under control.
⑤ Knob	Rotate the knob to remove a jammed card.
⑥ RFID Antenna Cover	Used to keep the RFID antenna in place.
⑦ RFID Antenna	Read the RFID tag on the film.
⑧ Upper Film Cartridge	Used to load the films in the upper side.
⑨ Cartridge Load/Eject Button	Used to remove or replace the cartridge.
⑩ Lower Film Cartridge	Used to load the films in the lower side.
⑪ Card Slot	Insert the cards to be laminated.

- MC-L2 (Upper Single-sided)

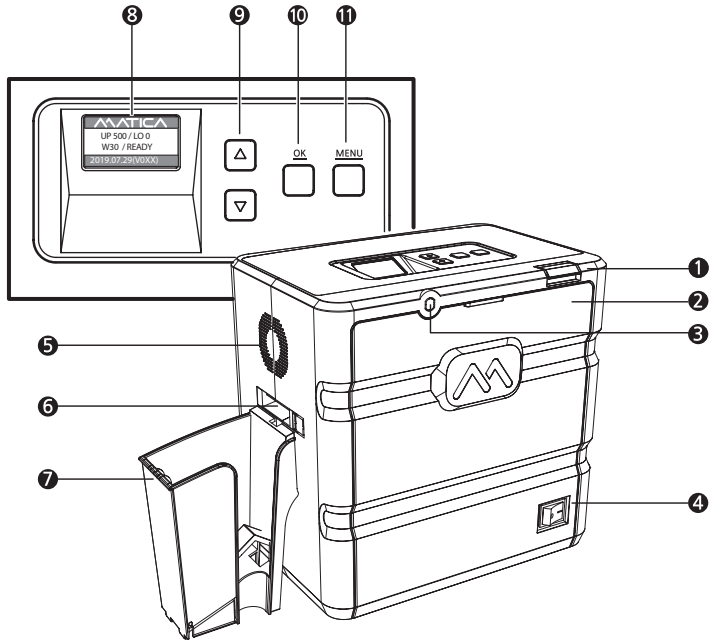

Name	Description
1 Front Cover Button	Opens the Front Cover.
2 Front Cover	Opens the cover to replace the Film and Cleaning Roller.
OPTION 3 Front Cover Lock	The Front Cover can be locked to protect the Film and other parts inside.
4 Power Switch	Turns the laminator on/off.
5 Fan Vent	Circulates air through the vent.
6 Card Ejector	Releases the laminated cards.
7 Card Stacker	Stacks the laminated cards. (max. 150 cards)
8 LCD Display	Displays the system status.
9 Menu Navigation Buttons	Used to navigate the menu or to cancel the lamination during the issuance.
10 OK Button	Used to confirm your choice on the menu or to issue the card.
11 Menu Button	Used to enter or exit the menu. (press once: enter, press once on the menu: exit)

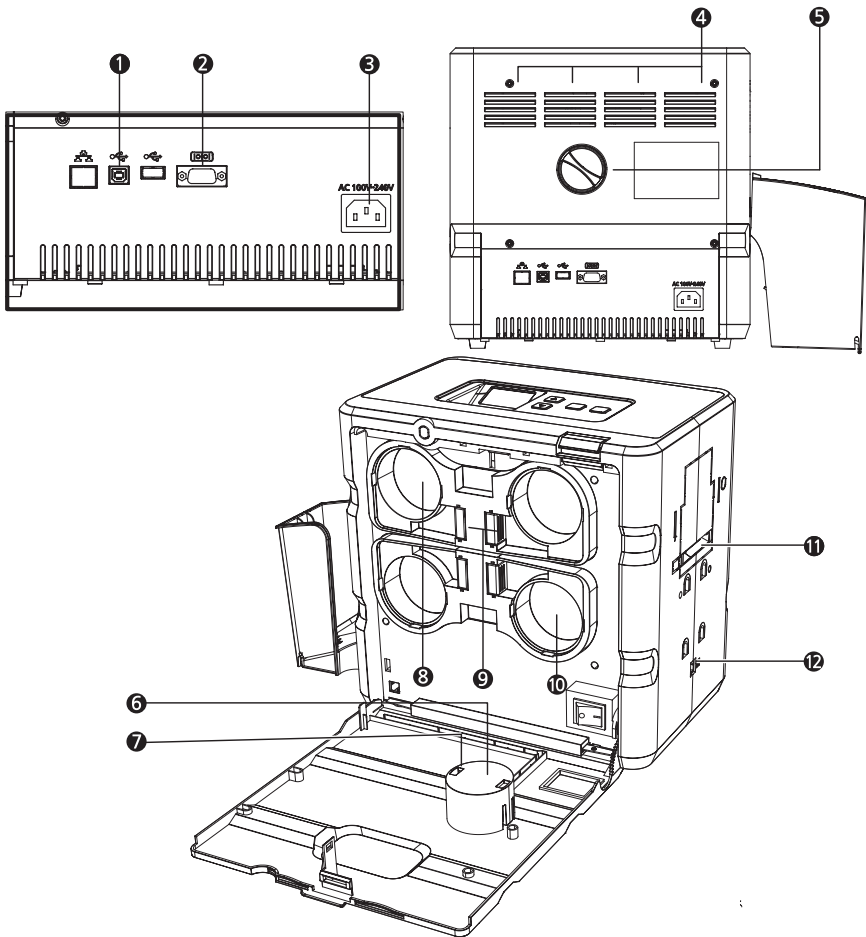

Name	Description
① USB Port	Used to connect the laminator and other devices using the USB cable.
② RS232C Port	Used to connect the laminator and other devices using the RS232C cable.
③ AC Power Port	Supplies power to the laminator using the AC power cable.
④ Air Vent	Circulates air to keep the temperature under control.
⑤ Knob	Rotate the knob to remove a jammed card.
⑥ RFID Antenna Cover	Used to keep the RFID antenna in place.
⑦ RFID Antenna	Read the RFID tag on the film.
⑧ Upper Film Cartridge	Used to load the films in the upper side.
⑨ Cartridge Load/Eject Button	Used to remove or replace the cartridge.
⑩ Lower Cartridge Cover	Used to protect the lower cartridge when not in use.
⑪ Card Slot	Insert the cards to be laminated.

-MC-L2 (Lower Single-sided)

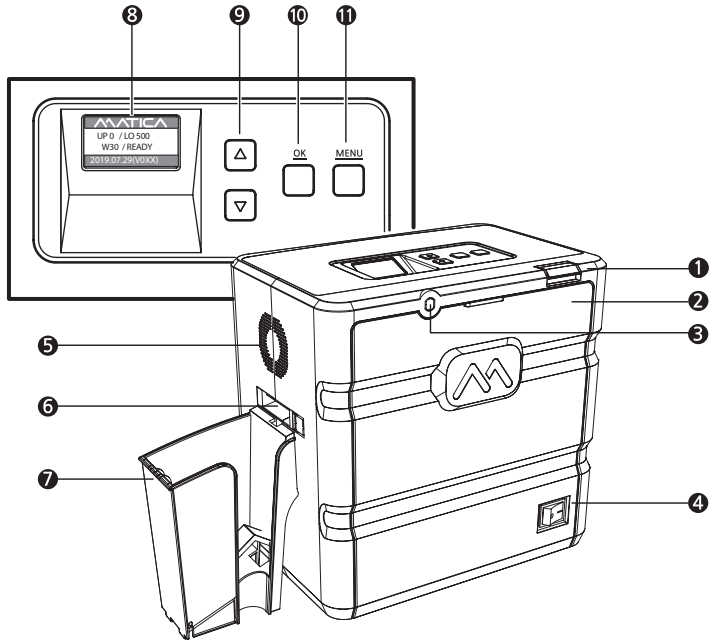

Name	Description
1 Front Cover Button	Opens the Front Cover.
2 Front Cover	Opens the cover to replace the Film and Cleaning Roller.
OPTION 3 Front Cover Lock	The Front Cover can be locked to protect the Film and other parts inside.
4 Power Switch	Turns the laminator on/off.
5 Fan Vent	Circulates air through the vent.
6 Card Ejector	Releases the laminated cards.
7 Card Stacker	Stacks the laminated cards. (max. 150 cards)
8 LCD Display	Displays the system status.
9 Menu Navigation Buttons	Used to navigate the menu or to cancel the lamination during the issuance.
10 OK Button	Used to confirm your choice on the menu or to issue the card.
11 Menu Button	Used to enter or exit the menu. (press once: enter, press once on the menu: exit)

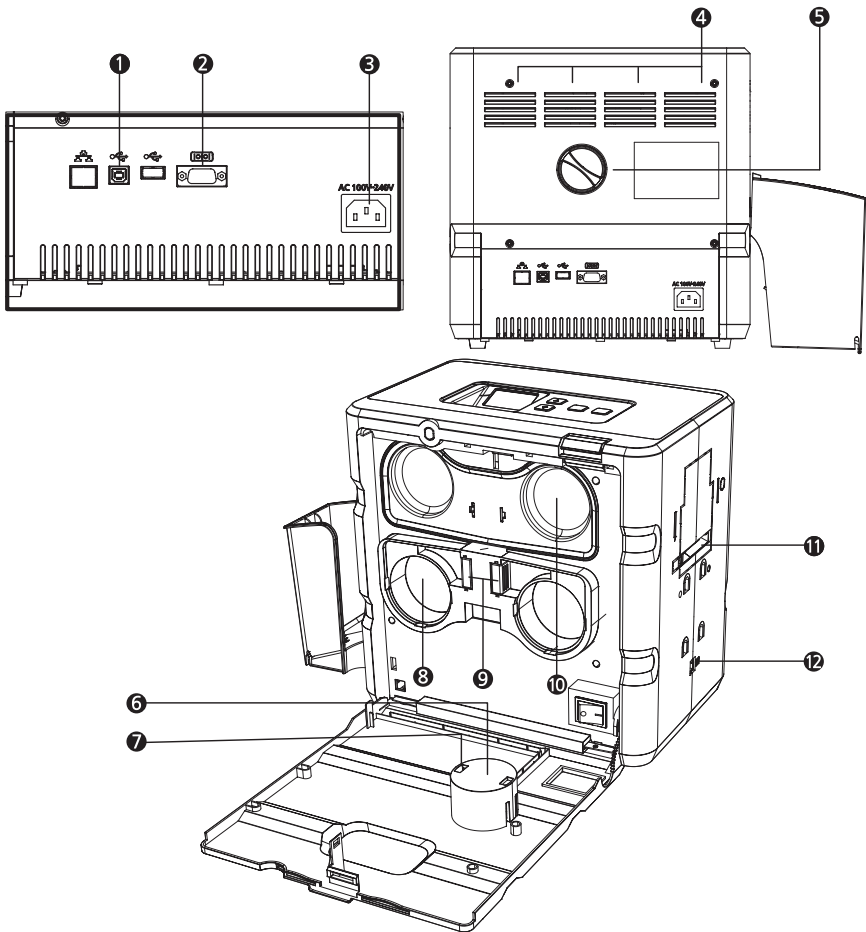

Name	Description
① USB Port	Used to connect the laminator and other devices using the USB cable.
② RS232C Port	Used to connect the laminator and other devices using the RS232C cable.
③ AC Power Port	Supplies power to the laminator using the AC power cable.
④ Air Vent	Circulates air to keep the temperature under control.
⑤ Knob	Rotate the knob to remove a jammed card.
⑥ RFID Antenna Cover	Used to keep the RFID antenna in place.
⑦ RFID Antenna	Read the RFID tag on the film.
⑧ Lower Film Cartridge	Used to load the films in the lower side.
⑨ Cartridge Load/Eject Button	Used to remove or replace the cartridge.
⑩ Upper Cartridge Cover	Used to protect the upper cartridge when not in use.
⑪ Card Slot	Insert the cards to be laminated.

Open Front Cover

1. Press the Front Cover Button.

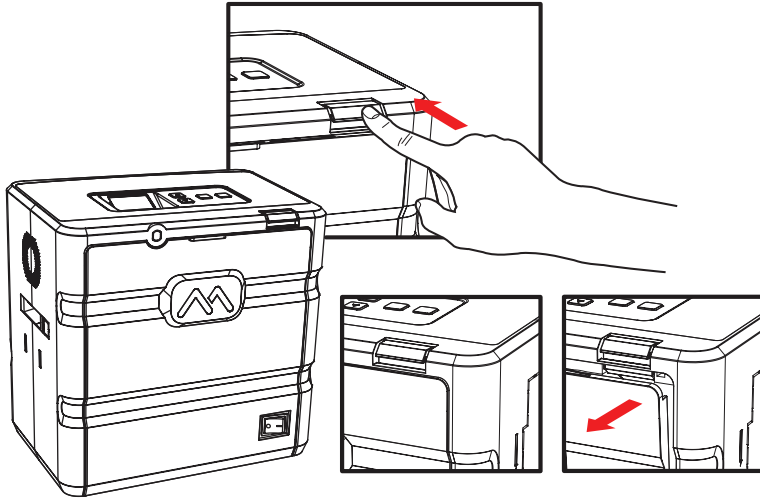

2. Once the cover opens slightly, pull the cover by the handle to open it completely.

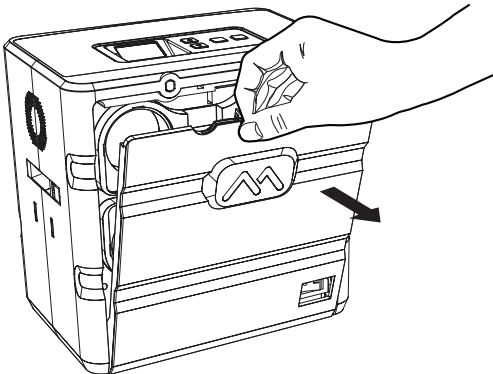
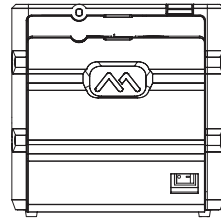

Close Front Cover

1. Push the Front Cover in until it "clicks".

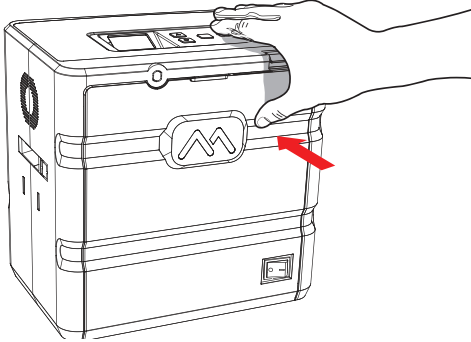

Caution

- Do not force the Front Cover in when the cartridge is not loaded correctly as it can damage the product.
- Cards will not be laminated properly if the Front Cover is not fully closed. (Make sure it is closed.)
- If the Front Cover is not closed completely, the LCD Display Panel indicates the message: "COVER OPEN".

Load Upper Cleaning Roller & Films

-Load Upper Cleaning Roller

1. Pull the cartridge out while pressing the Cartridge Load/Eject Button to remove it from the laminator.

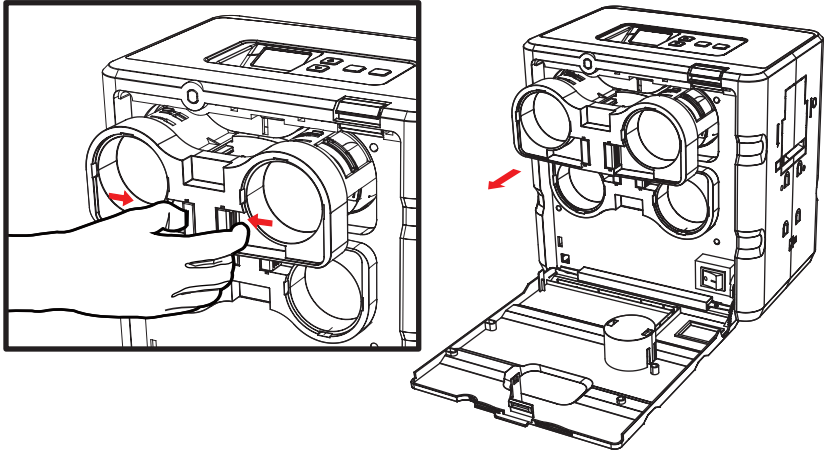

2. Align the Cleaning Roller with its hole and push it down until it clicks.

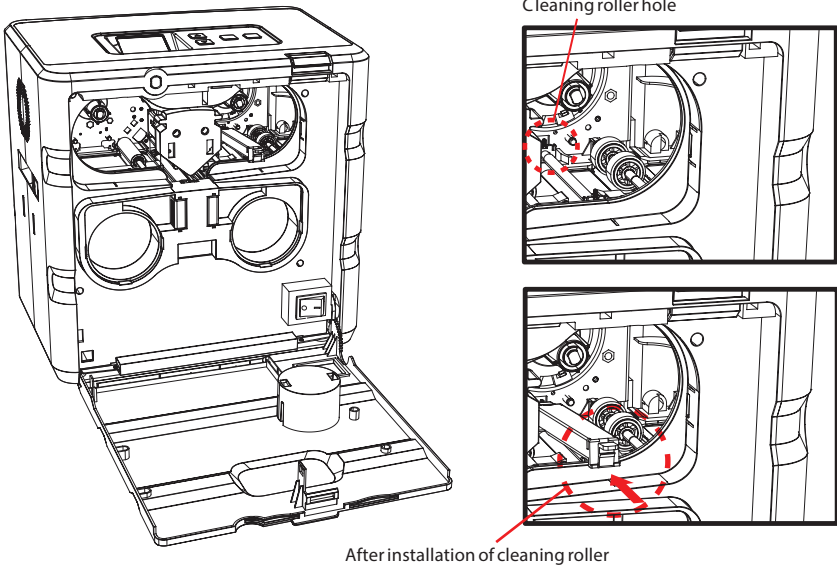

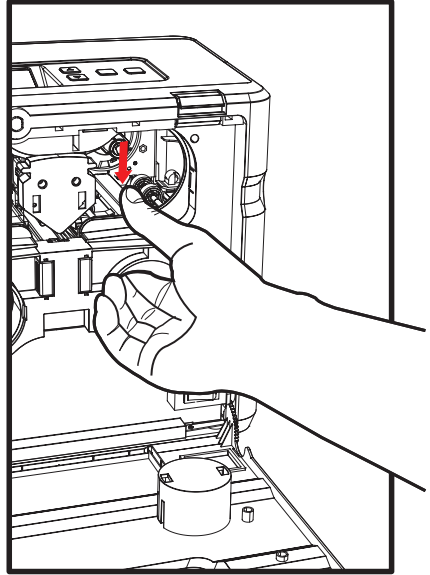
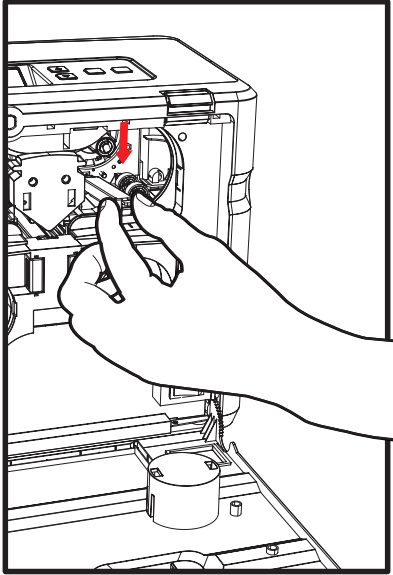

Caution

- Make sure that it is fully inserted into the Cleaning Roller Hole before pushing the indicated area.

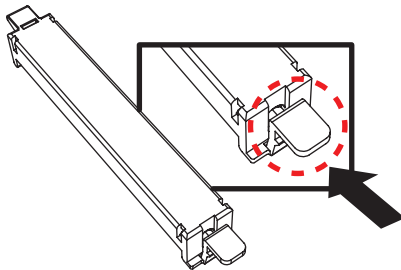

-Load Films to Upper Cartridge

1. Load the films in the correct position as shown in the image below.

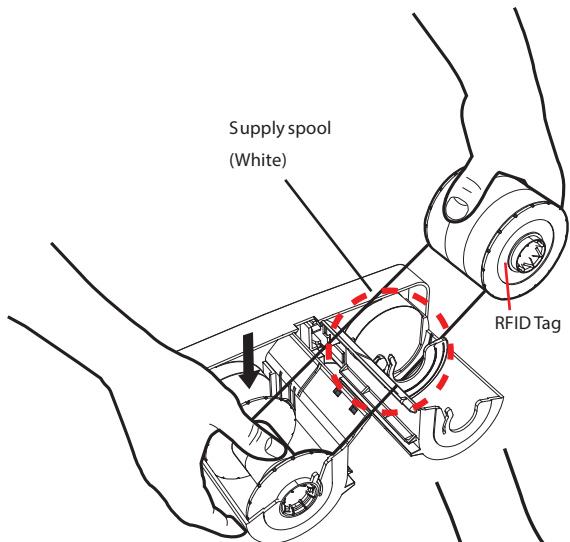

Caution

- Place the white film core on the core guide.
- The white film core does not fit the black film core guide.
- Do not force the film core in as it can damage the cartridge.
- Check the position of the RFID tag.



Caution

Load the film tight into the cartridge.

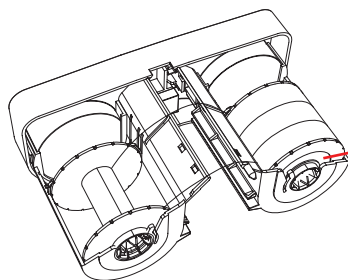
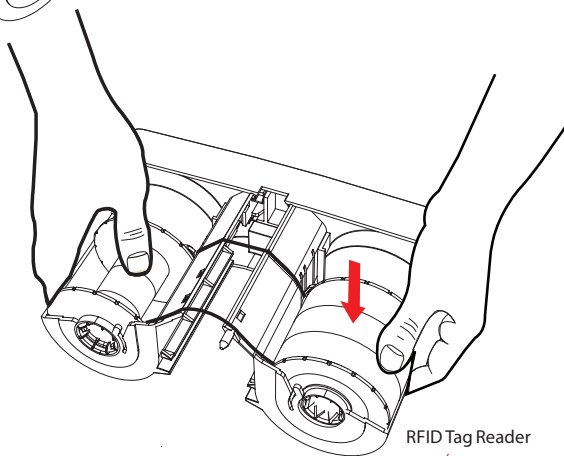

RFID Tag position

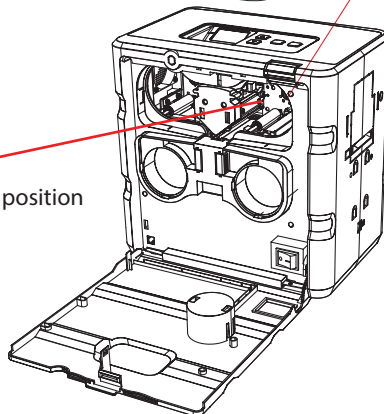

RFID Tag Reader

2. Check the position of the Upper Film Cartridge and films for rewinding and push the cartridge in until it clicks.

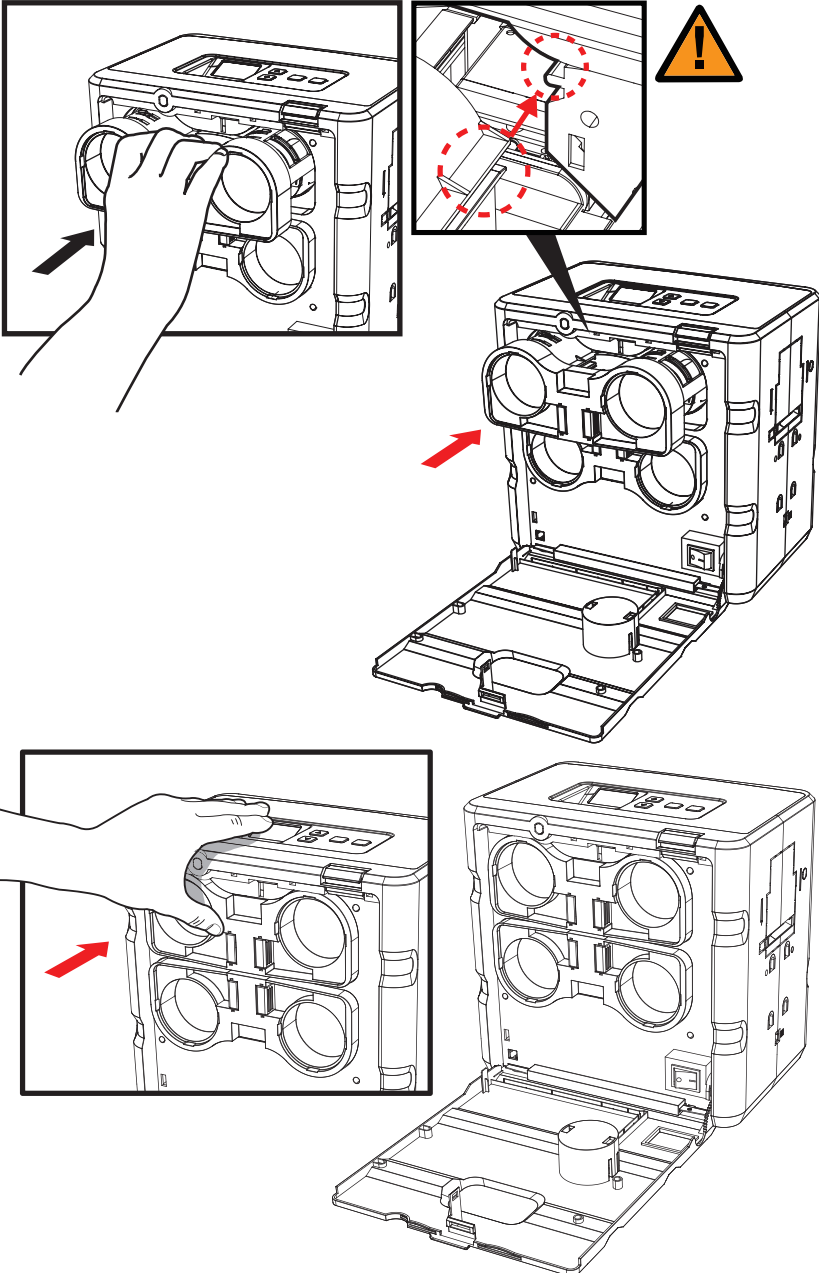

Load Lower Cleaning Roller & Films

-Load Lower Cleaning Roller

1. Pull the cartridge out while pressing the Cartridge Load/Eject Button to remove it from the laminator as shown in the image below.

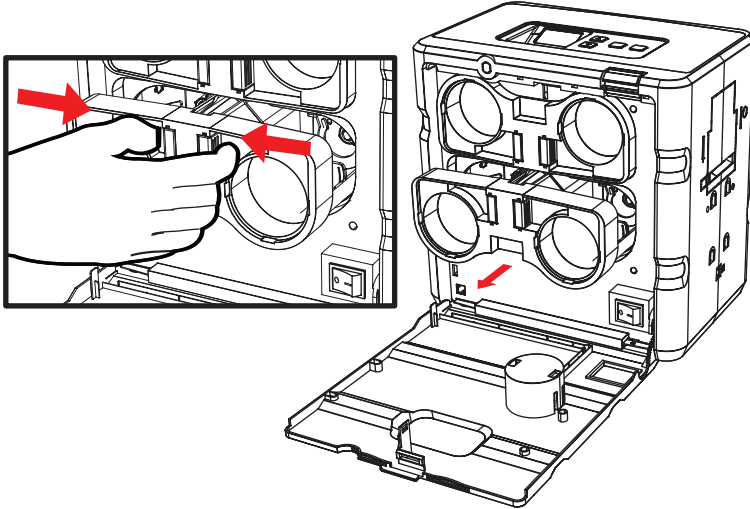

2. Align the Cleaning Roller with its hole and push it up until it clicks.

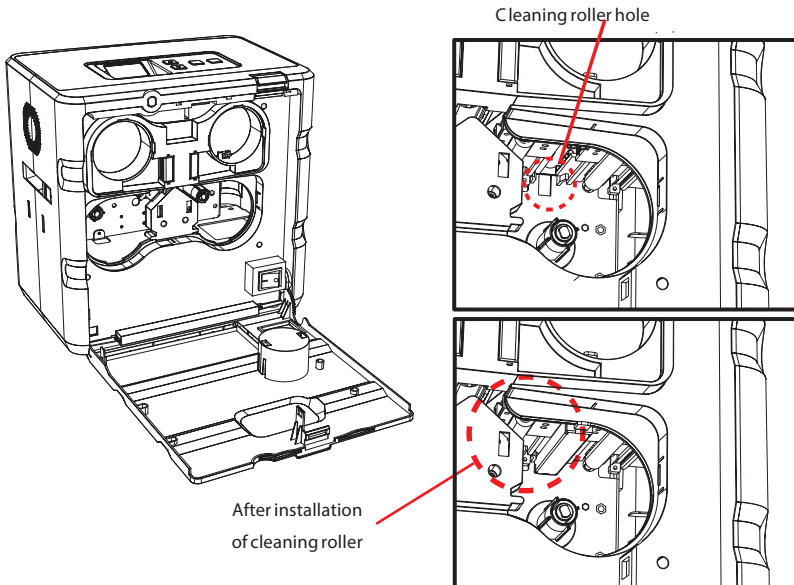

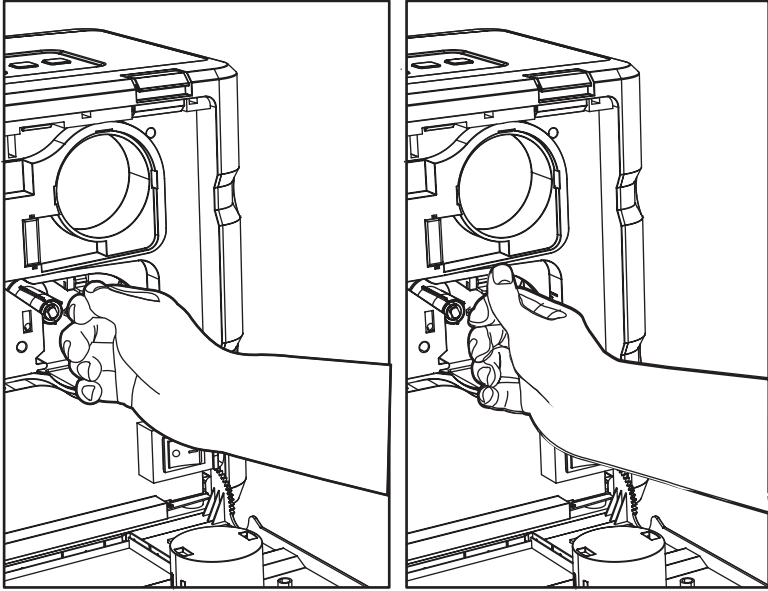

Caution

- Make sure that it is fully inserted into the Cleaning Roller Hole before pushing the indicated area.

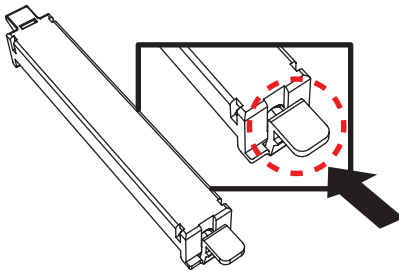

-Load Films to Lower Cartridge

1. Load the films for lamination and rewinding in the correct position as shown in the image below.



Caution

- Place the white film core on the core guide.
- The white film core does not fit the black film core guide.
- Do not force the film core in as it can damage the cartridge.
- Check the position of the RFID tag.



Caution

Load the film tight into the cartridge.

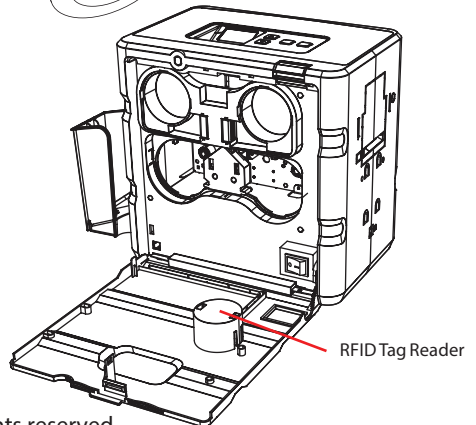
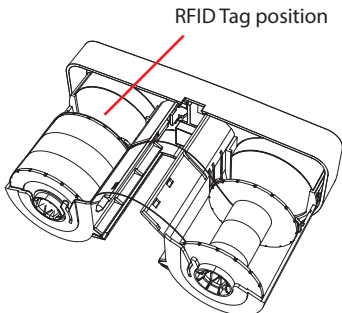
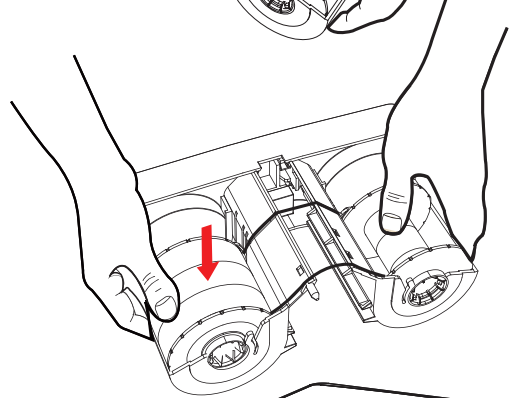
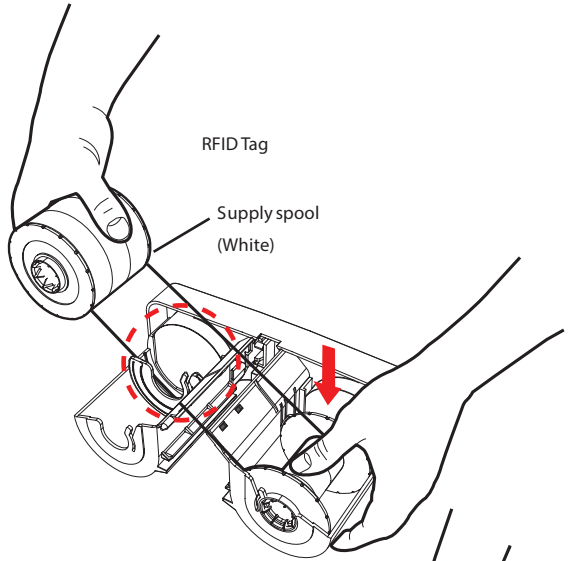

2. Check the position of the Lower Film Cartridge and films for rewinding and push the cartridge in until it clicks.

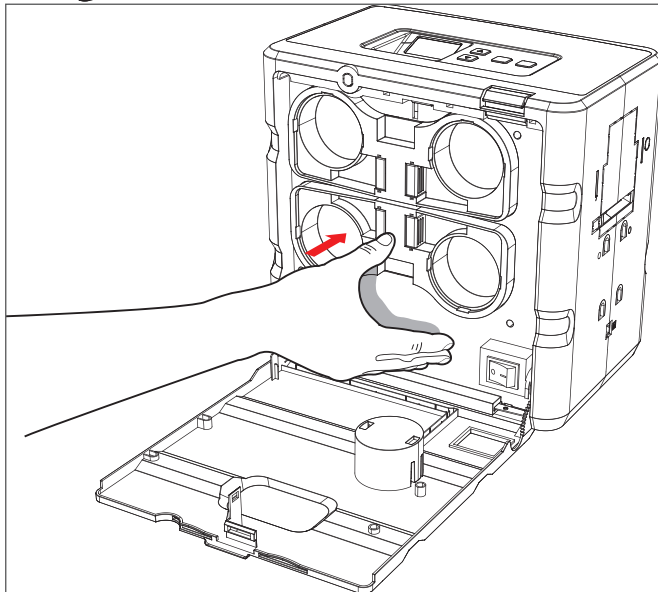
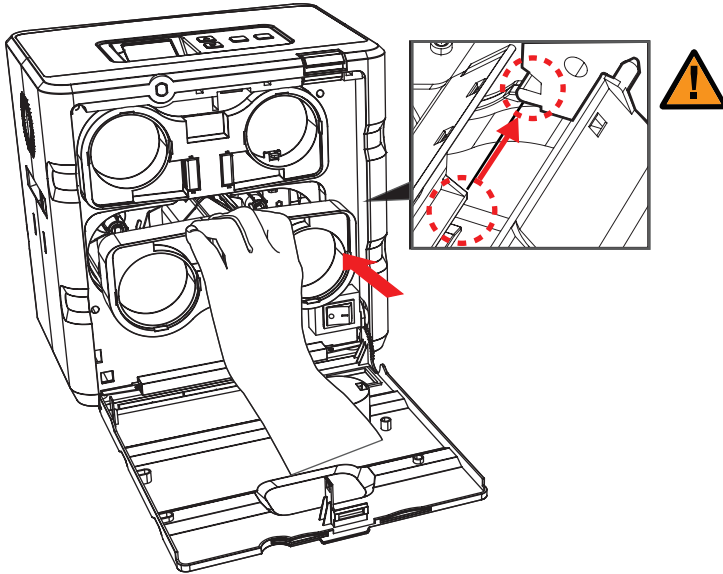

Load/Unload Card Stacker to Laminator

-Load Card Stacker to Laminator

Insert the hook on the Card Stacker and push it down in the side of the laminator. (Max. 150 cards can be loaded at once.)

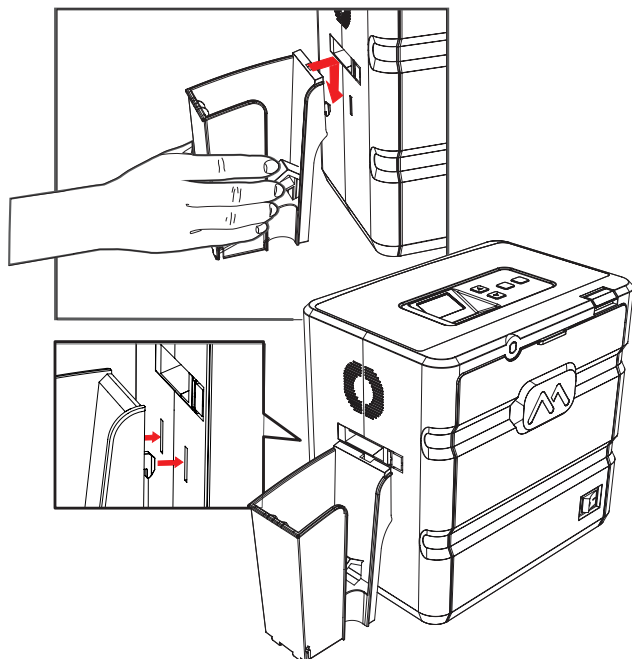

-Remove Cards after Taking Out Card Stacker

Hold the side of Card Stacker and pull it up to remove as shown in the image.

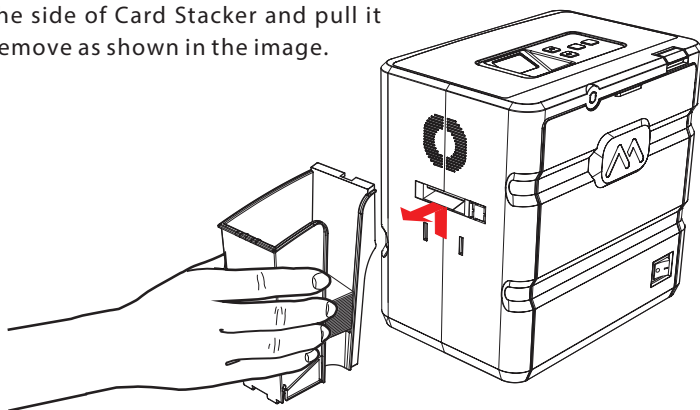

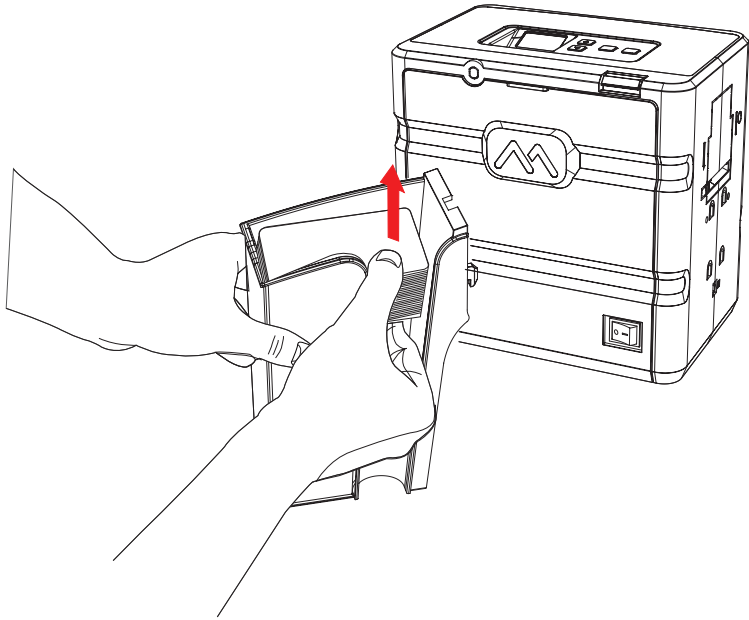

-Remove Cards without Taking Out Card Stacker

Use your thumb and index finger to take out 60 or fewer cards from the Card Stacker without removing it from the laminator.

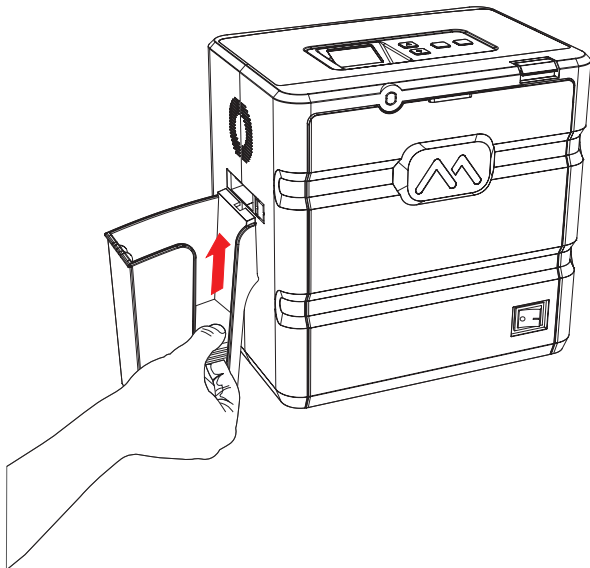

Connect Power & Communication Cables

-Connect Power Cable

Make sure that the Power Switch is off and connect the AC Power Cable to the Power Port on the back of the laminator.

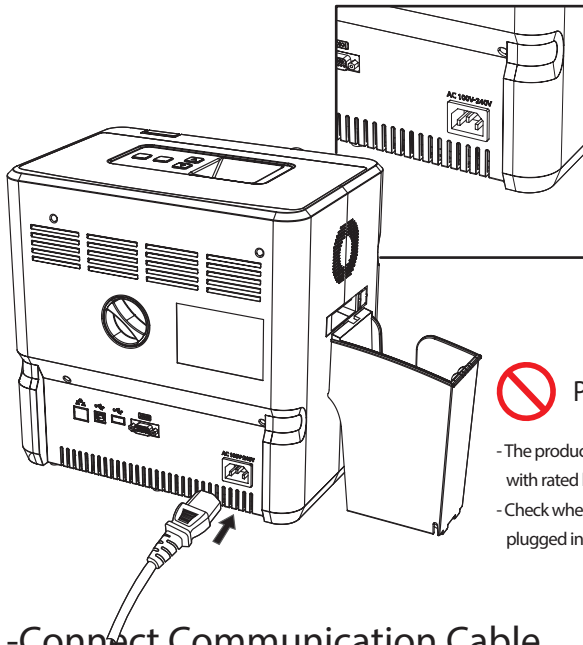

 Prohibition

- The product must be used with AC power with rated label.
- Check whether the Power Cable is plugged in before use.

-Connect Communication Cable

To download the firmware, connect the laminator to a PC using either USB Port or RS232C.

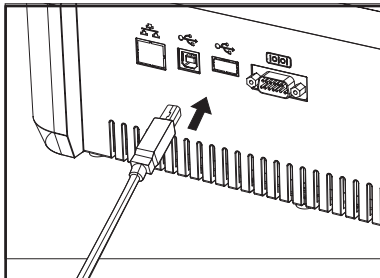

USB Port

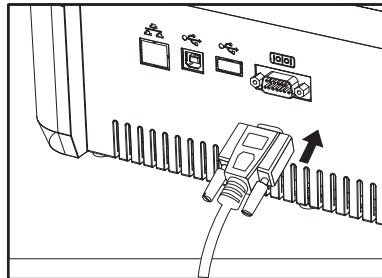

RS232C Port

Power On

Press the Power Switch (☒) to turn the laminator on.

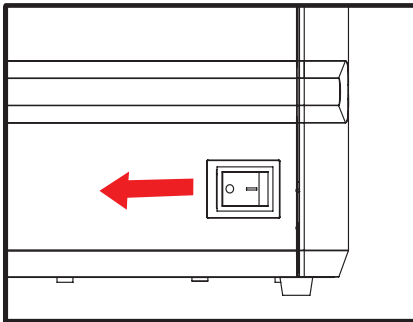
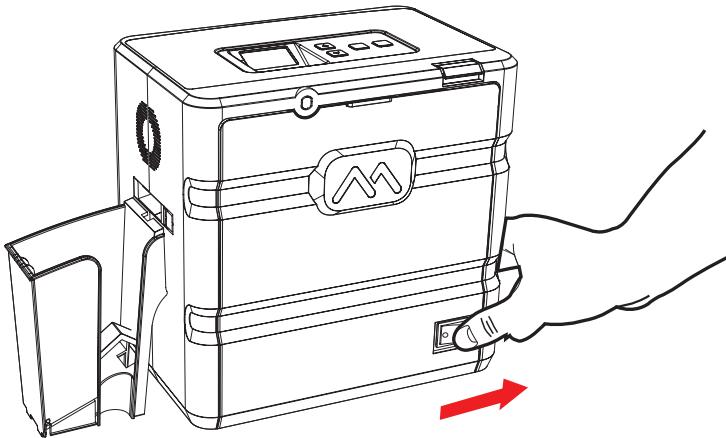

Power ON -> OFF

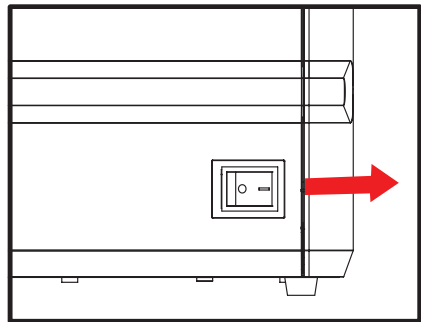

PowerOFF -> ON



Electrical Hazard / Fire Hazard

If the product is exposed to rain or liquid, please turn off an
service representative.

d unplug the cable, and contact an authorized

Front Cover Lock

Turn the key clockwise to lock the Front Cover.

The key cannot be pulled out if the Front Cover is not closed. Do not force it out as it can damage the Front Cover.

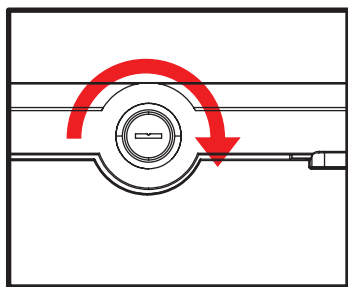
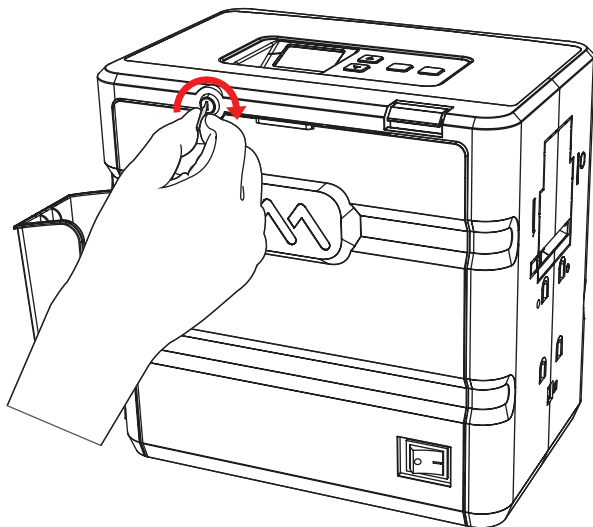

Unlocked -> Locked

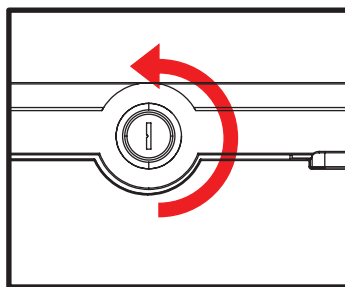

Locked -> Unlocked

Button Control & Menu

-Buttons

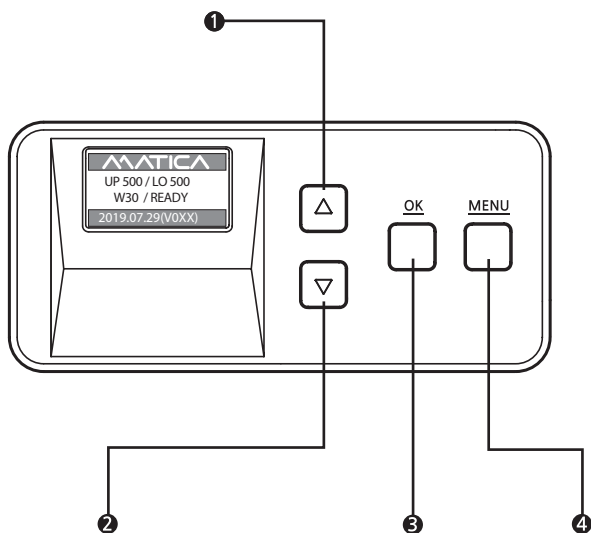

Name	Description
① Menu Navigation (Up)	Increase the value or navigate the menu.
② Menu Navigation (Down)	Decrease the value or navigate the menu.
③ OK	Used to set the value or issue the card.
④ Menu	Used to enter or exit the menu or to cancel the lamination during issuance.

-Description on Laminator Status on LCD

Status on LCD 3rd line	Description	Note
Initialize	When device is connected to power, checks status of each module.	
Ready	Ready for lamination.	
Rib Check	Check status of card lamination film, information.	
Warm up	Show "Warm up" sign before lamination heating roller gets set.	
Laminating	During the card lamination.	
W10/Ready	Ready for lamination, but remain quantity of film is less than 40 cards.	
Insert Card	When card is being inserted from card input hopper to laminator.	
W11 Clean Lam	The film life is reduced to 40 cards or less, or requires cleaning inside of laminator.	
W30 Clean Lam	The laminator needs to be cleaned inside.	

-Laminate side setting(Pass Mode)

Function: Set pass mode

1. Press 'MENU' to enter the menu mode.

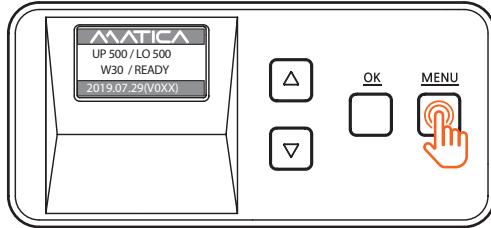

2. Press 'OK' when '1. Pass mode' appears on the LCD display.

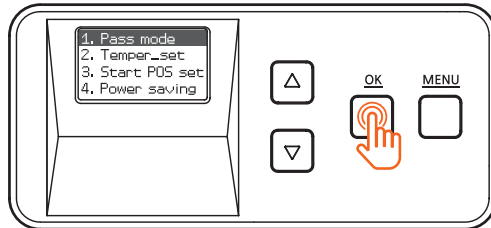



Note

- In the Pass mode, you can choose 'Auto', 'Alone_upper', 'Alone_lower', 'Both' or 'Bypass'.
Use the menu navigation buttons to navigate the menu.

Auto

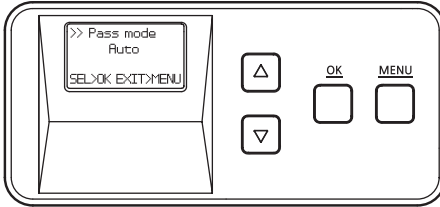

Select this option to laminate a card automatically according to the way of film loading (Default setting)

Alone_upper

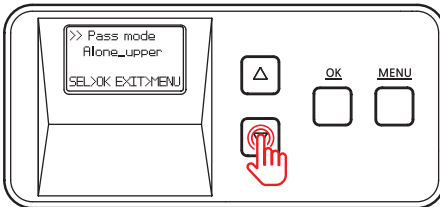

Select this option to laminate the upper side only.



Caution

- In the Alone Upper Mode, an error occurs if any film is loaded in the lower cartridge

Alone_lower

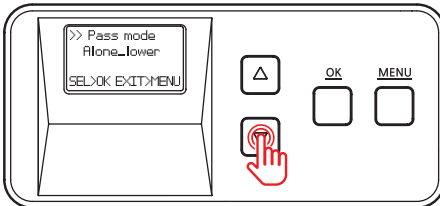

Select this option to laminate the lower side only.



Caution

- In the Alone Lower Mode, an error occurs if any film is loaded in the lower cartridge

Both

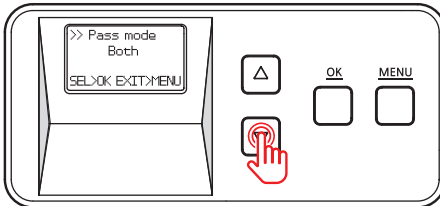

Select this option to laminate both upper and lower sides.

Bypass

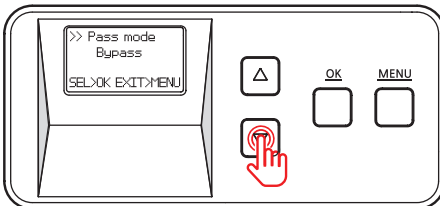

Select this option to pass without laminating either upper or lower side.

3. After selecting the pass mode, press 'OK' to go back to the previous step.

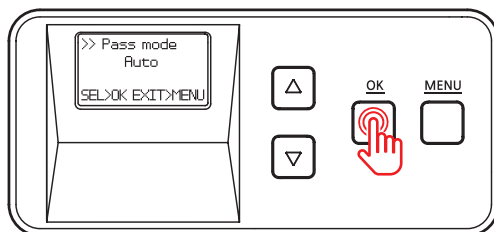

4. Press 'MENU' to go into the standby mode.

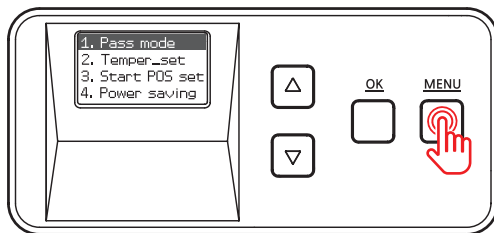

5. If any changes have been made, you will be prompted to save the changes.
Press 'OK' to save the new settings or 'MENU' if you do not want to save them.

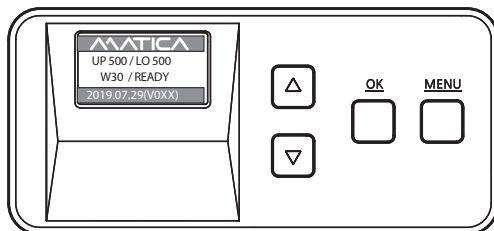
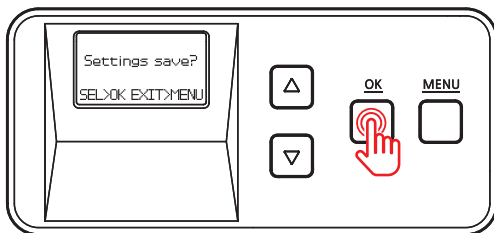

-Lamination Temperature (Temper_set)

Function:

Set the lamination temperature.

It should be differently set according to the type of film, pass mode and card stock.

You can set the temperature between 120°C and 185°C (248°F and 365°F)

+/- increments of 5°C (9°F)

Filmtype	Range of recommended temperature for dual sided lamination	Range of recommended temperature for single sided lamination
Clear (1.0mil)	160°C - 175°C (320°F - 347°F)	170°C - 180°C (338°F - 356°F)
Hologram (1.0 mil)	160°C - 175°C (320°F - 347°F)	170°C - 180°C (338°F - 356°F)



Caution

- The laminated film may be easily separated if the lamination temperature is lower than the recommended temperature.
- Card jam error or card bending issue can be occurred if the lamination temperature is higher than the recommended temperature.

1. Press 'MENU' to enter the menu mode.

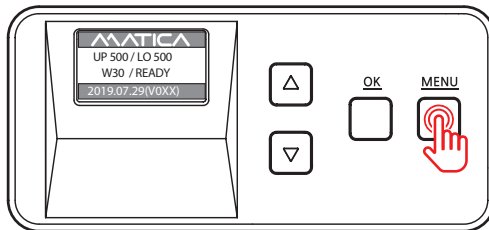

2. Press the menu navigation button to select '2. Temper_set' and press 'OK'.

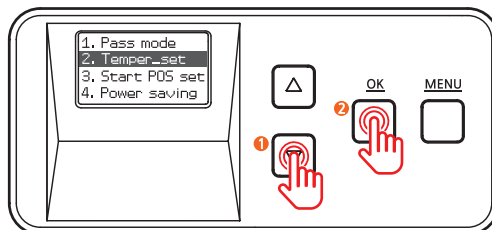

3. Use the menu navigation buttons to adjust the temperature for the lamination heater.

It can be set between 120°C and 185°C (248°F and 365°F)

+/- increments of 5°C (9°F)

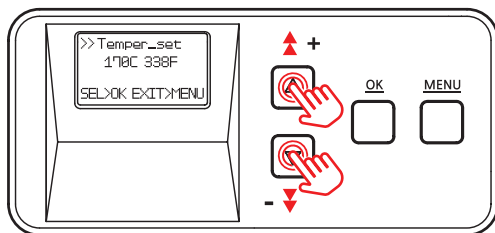

4. Press 'OK' to set the temperature and go back to the previous step.

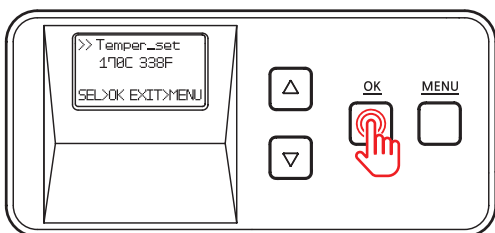

5. Press 'MENU' to go into the standby mode.

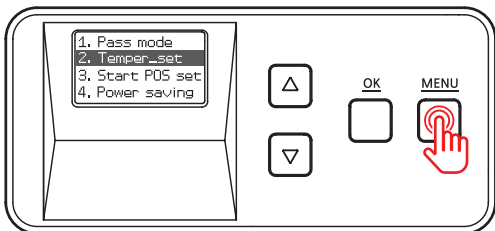

6. If any changes have been made, you will be prompted to save the changes.

Press 'OK' to save the new settings or 'MENU' if you do not want to save them.

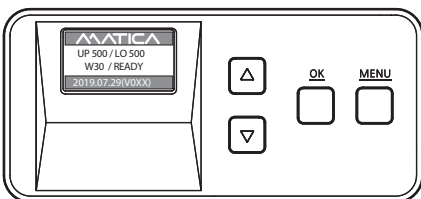
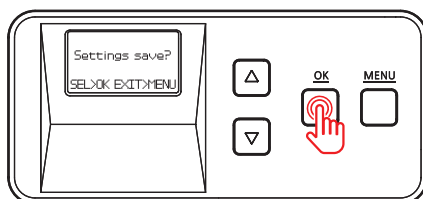

-Film Position (Start POS set)

Function:

Set the position of film and card for lamination.

- It can be set between -1.0mm ~ +1.5mm +/- increments of 0.1mm.

From the direction of inserting the card, it moves back by '- (L)' value and forward by '+ (R)'.

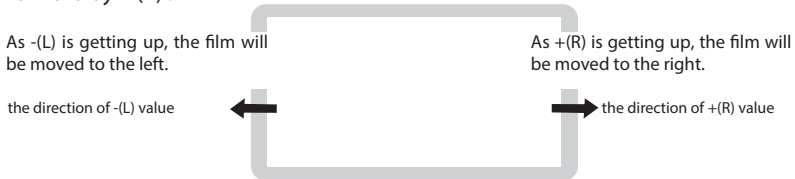

1. Press 'MENU' to enter the menu mode.

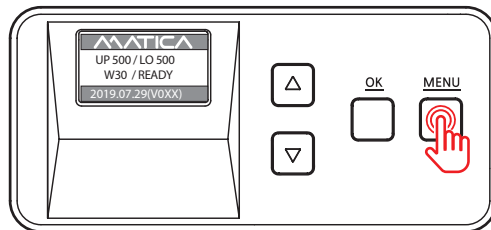

2. Press the Menu Navigation Button to select '3. Start POS set' and press 'OK'.

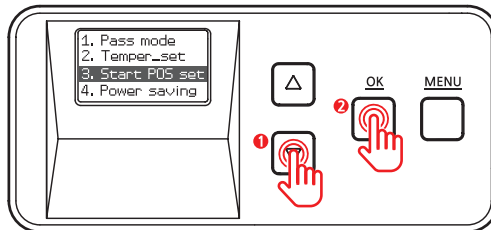

3. Use the Menu Navigation Button to adjust the position to laminate. (It can be set between -1.0mm ~ +1.5mm +/- increments of 0.1mm.)

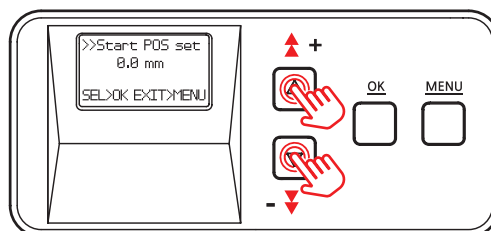

4. Press 'OK' to set the position and go back to the previous step.

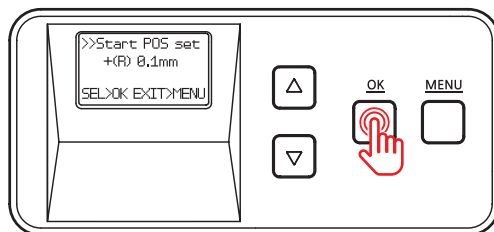

5. Press 'MENU' to go into the standby mode.

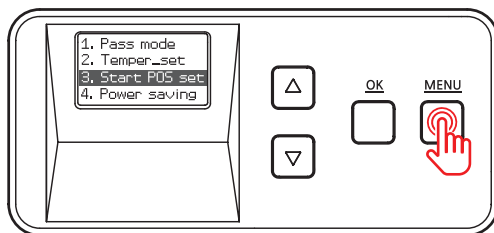

6. If any changes have been made, you will be prompted to save the changes.
Press 'OK' to save the new settings or 'MENU' if you do not want to save them.

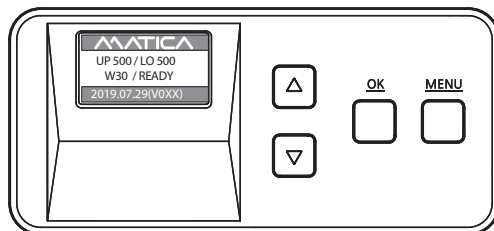
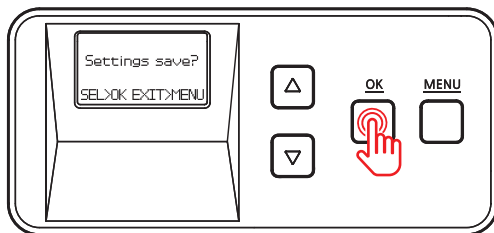

-Power Saving Mode

Function:

It limits unnecessary heating while the device's inactive for long time usage of spare parts and reduce power consumption.

The system turns off if it is inactive for a set duration of time. It can be set between 5 and 60 minutes +/- increments of 5 minutes.

ex) If you set 10 minute for Power Saving Mode, the device starts power saving mode 10 minutes after last card lamination.

But after Power Saving Mode, NL200 may needs 'Warm Up' up to 40~60sec before usage.

1. Press 'MENU' to enter the menu mode.

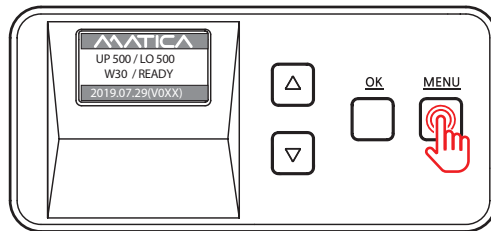

2. Press the Menu Navigation Button to select '4. Power saving' and press 'OK'.

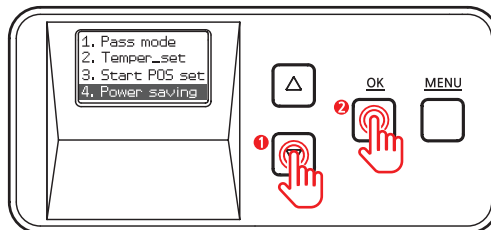

3. Use the Menu Navigation Button to set the power saving mode.
(It can be set between 5 and 60 minutes +/- increments of 5 minutes.)

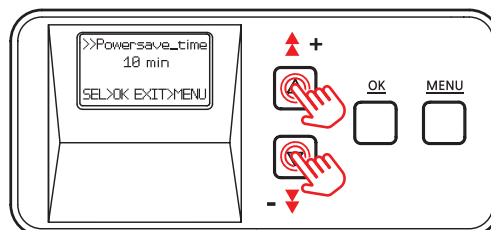

4. Press 'OK' to set the power saving mode and go back to the previous step.

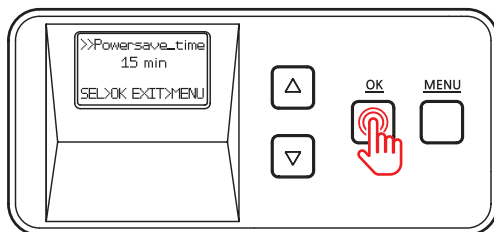

5. Press 'MENU' to go into the standby mode.

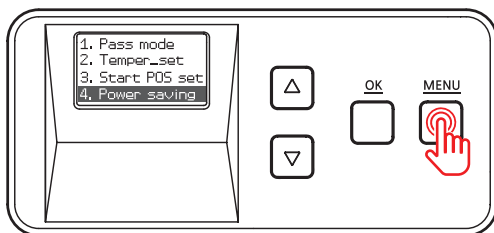

6. If any changes have been made, you will be prompted to save the changes.
Press 'OK' to save the new settings or 'MENU' if you do not want to save them.

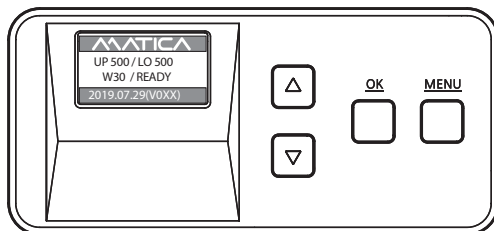
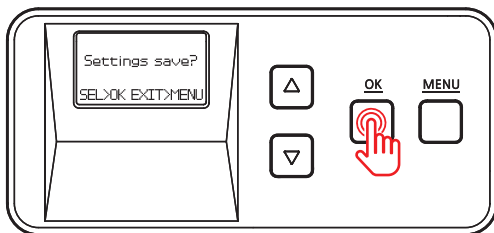

-Path Sensor

Function: Check whether the path sensor works correctly.

1. Press 'MENU' to enter the menu mode.

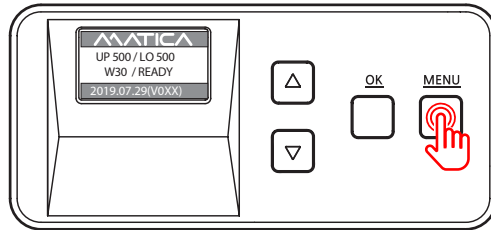

2. Press the Menu Navigation Button to select '5. Path sensor' and press 'OK'.

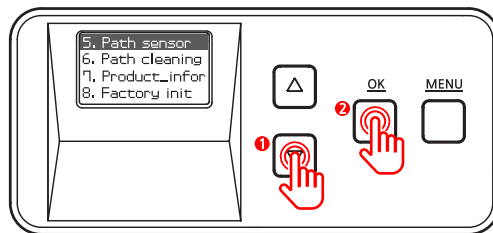

3. Insert a blank card into the Card Slot.
(Make sure to hold the card until the operation starts.)

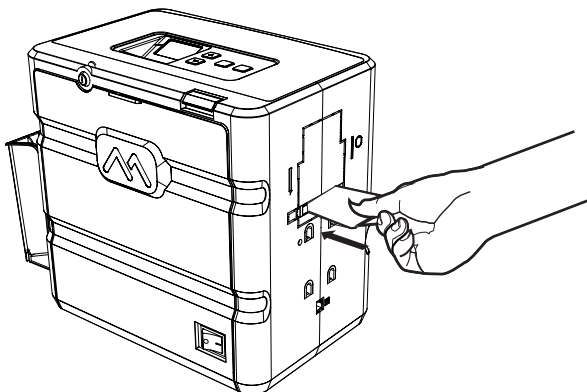

4. Press 'OK' while holding the card and it goes in.

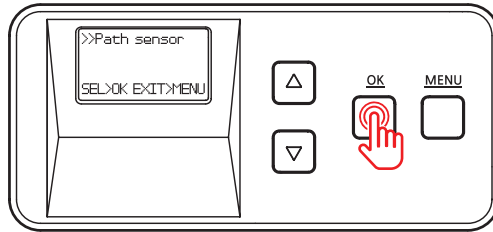

5. The card will move back and forth 5-6 times. Each time the card passes the sensor, the indicator changes from X to O.

O : Card detected, X : No Card detected

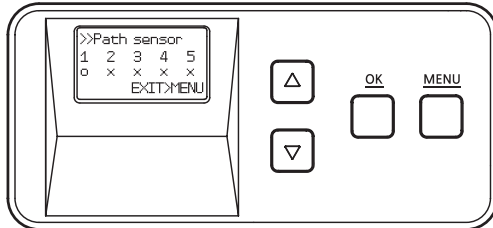

Note 1st sensor turns on when a card is inserted through the feeding slot. #2,#3,#4,#5 sensors are automatically turned on and off in the order after a card is inserted into the Laminator. When you have a card jam issue, please check the status of all path sensors. If you find any troubled sensor, contact to the customer service center.

6. The laminator releases the card upon completion.

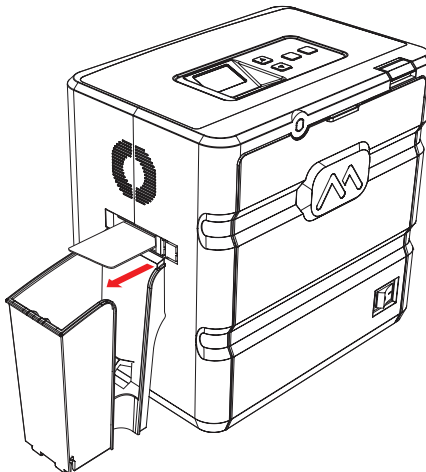

7. Press 'MENU' to go back to the previous step.

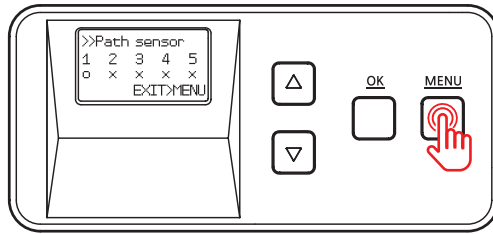

8. Press 'MENU' to go into the standby mode.

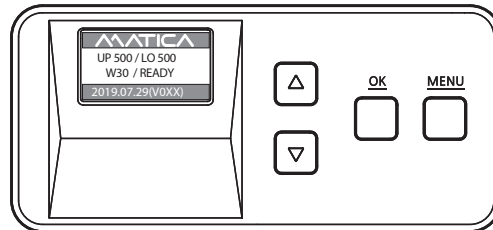
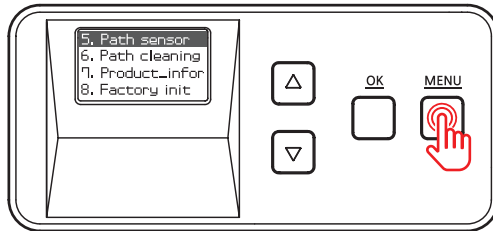

-Serial No. (Product_infor)

Function: check the serial number of the product.

1. Press 'MENU' to enter the menu mode.

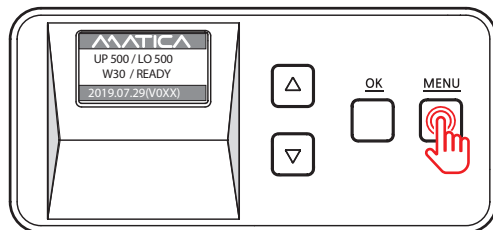

2. Press the menu navigation button to select

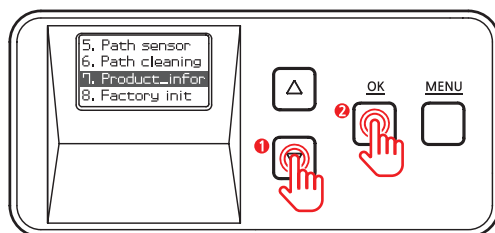

3. Check the serial number.

The first 4 digits indicate the year and month of manufacture and the last 4 digits mean production lot number.

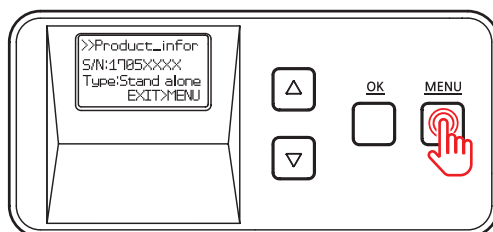

4. Press 'MENU' to go back to the previous step.

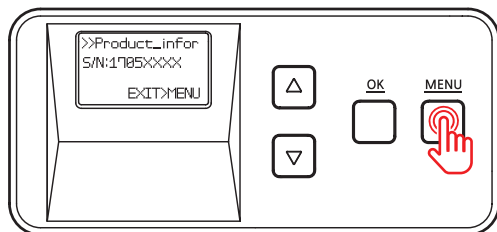

5. Press 'MENU' to go into the standby mode.

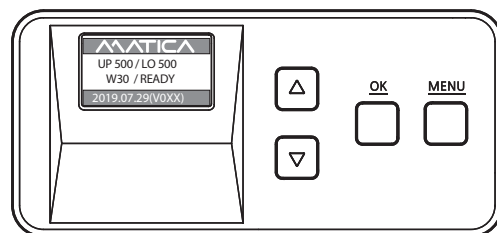
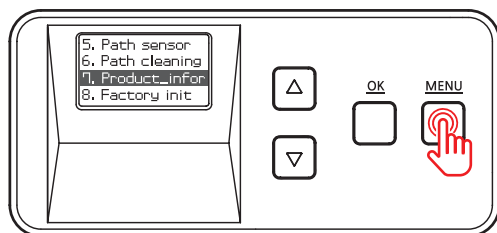

-Factory Reset (Factory init)

Function:

Reset the system to factory default settings.

Default Settings: Pass mode: Auto, Temper_set: 160 (320),

Start_POS set: 0mm, Power_saving: 5min

1. Press 'MENU' to enter the menu mode.

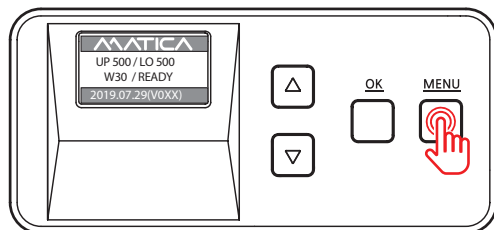

2. Press the Menu Navigation Button to select '8. Factory init' and press 'OK'.

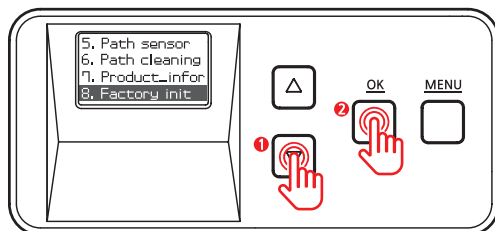

3. Press 'OK' and 'Setting init?' appears on the screen.

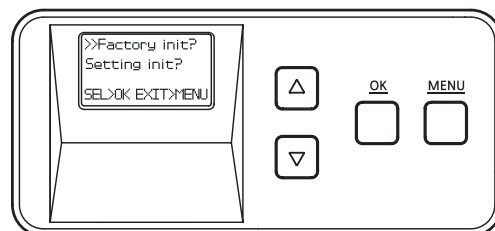
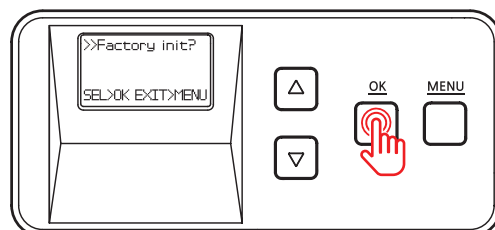

4. Press 'OK' to proceed or 'MENU' to cancel the action. (You will be directed to the previous step when you press either 'OK' or 'MENU' .)

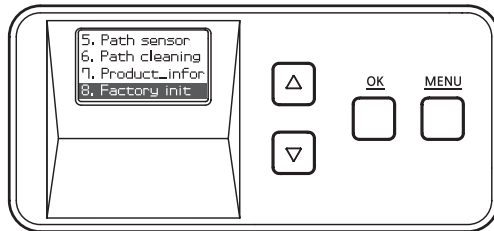
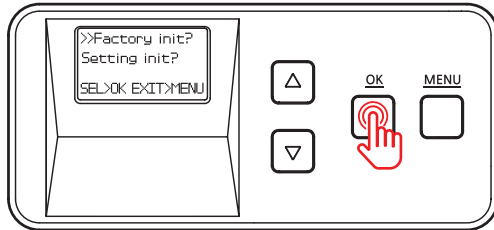

5. Press 'MENU' to go into the standby mode.

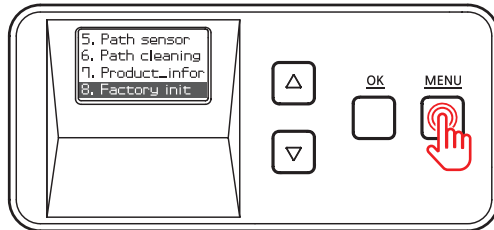

Set Count (Designate the numbers of cards to be laminated)

1. Press 'MENU' button.

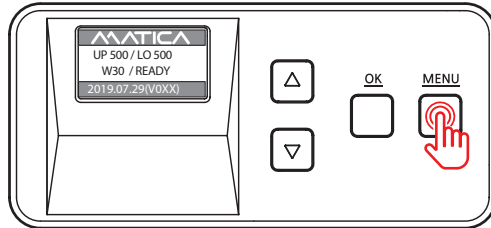

2. Press the Menu Navigation button to select '9. Hopper set' and press 'OK'.

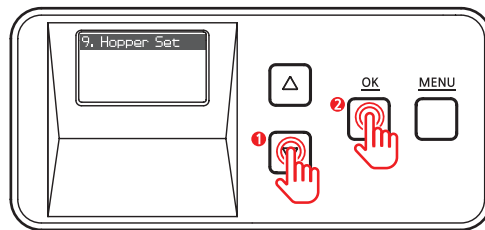

3. Use the Menu Navigation Button to select card input setting.

3-3 Set Count (Designate the numbers of cards to be laminated)

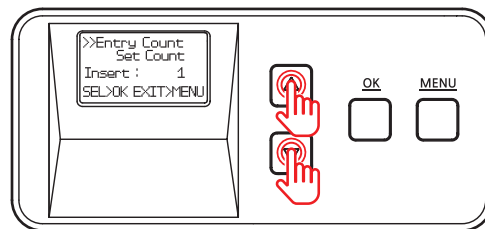

4. Press 'OK' button on 'Set Count' step.

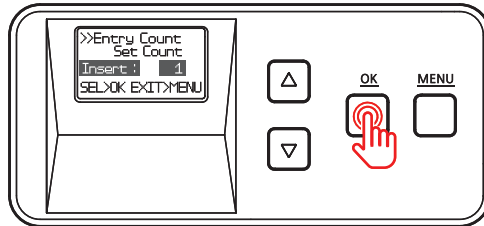
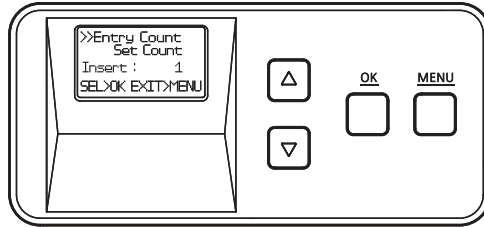

When press 'OK' button on Set Count menu

5. Use the Menu Navigation button to adjust quantity of card

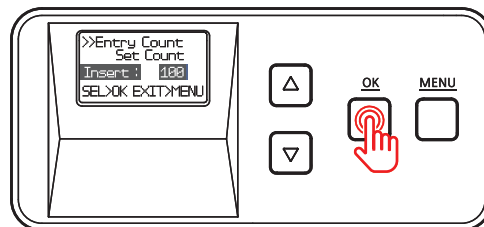
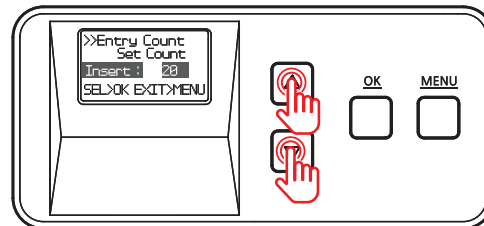

6. Press 'OK' and go back to the previous step.

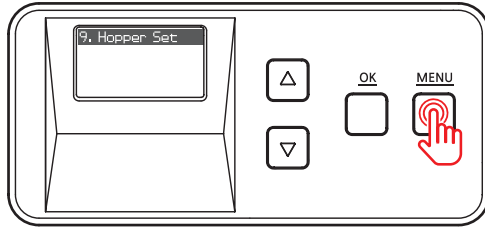

7. Press 'MENU' button and go back to 'Ready' position.
If any changes have been made, you will be prompted to save the changes. Press 'OK' to save the new settings or 'MENU' if you do not want to save them.

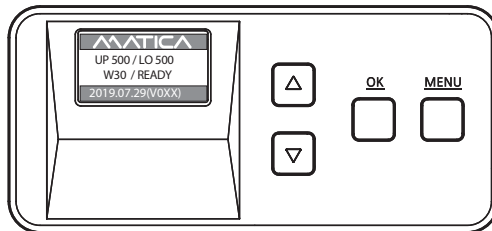
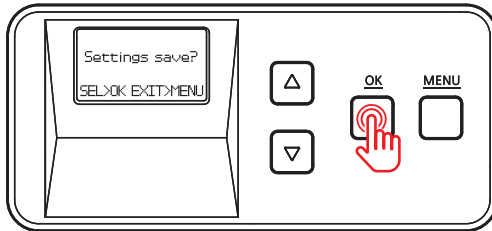

-Card issuance and cancel

1. When you finish the setting, press 'OK' button to issue the card.

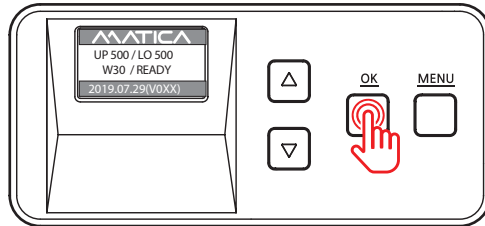

2. Press 'MENU' button to cancel the laminating during the issuance.

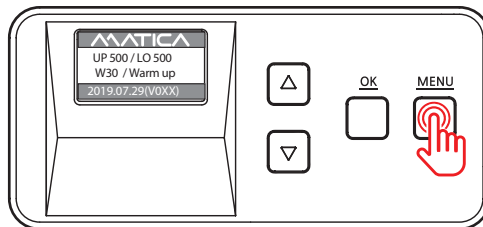

Note

You can cancel the laminating during the 'Warming-up'. You can't cancel the laminating job when the laminating is operated.



Maintenance Instructions

-Supported Cards

The following cards are recommended for the prevention of jams and the best results.

① Size

- International Standard (CR-79, CR-80 ISO 7810)
- CR-80 (53.98mm (W) x 85.60mm (L) / 2.215" x 3.375")
- CR-79 (51mm (W) x 83.9mm (L) / 2.051" x 3.303")

② Thickness

- Standard: 0.76mm~1.0mm (30mil~40mil)

③ Acceptable Cards

- Glossy white
- Free of dirt or grease
- Not contaminated
- Free of scratches or dents
- Completely flat
- Static Free

④ Unacceptable Cards

- Heavily damaged
- Stained or contaminated
- Scratched
- Bent or deformed
- Embossed



Caution

Do not use cards considered unacceptable as they may damage the parts.

Clean the Laminator

-Clean the Exterior

- Make sure to turn off the laminator and unplug the power cable before cleaning it with a soft cloth slightly dampened with water.
- Do not allow any liquid to drip inside the product.
- Make sure that the laminator is dry before turning it on.



Caution

Do not use any liquid / gel containing a high content of alcohol or solvent clean the laminator as it may cause discoloration or fissure on its surface.

-Clean Roller Using Cleaning Card

It is recommended to clean the laminator using the cleaning card every month or each time 500 cards are laminated in order to maintain quality and prevent damage to the important parts.

1. Press 'MENU' to enter the menu mode.

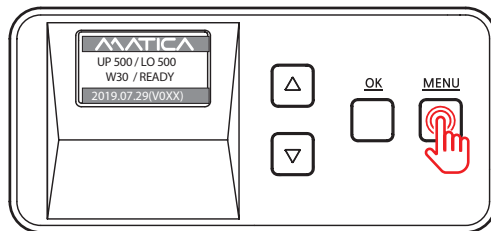

2. Press the menu navigation button to select '6. Path cleaning' and press 'OK'.

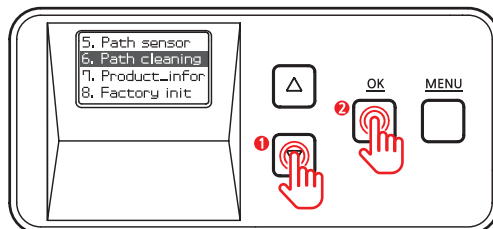

3. Insert the cleaning card to the card eject slot, not card input slot.
(Make sure to hold the card until the operation starts.)

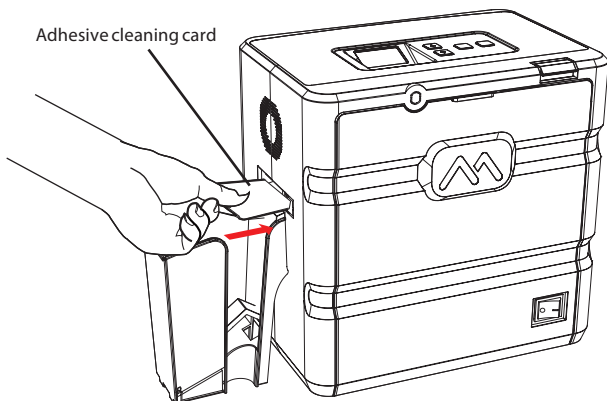

Fire Hazard

Please be sure to use Adhesive cleaning card.
Alcohol type cleaning card may cause fire.

4. Press 'OK' while holding the card and it goes in.

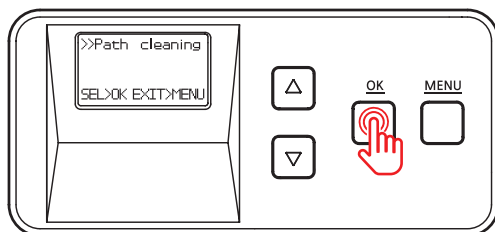

5. The card will move back and forth 3-4 times while cleaning the roller.

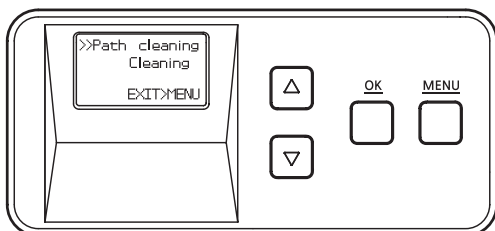

6. The card will be released once the cleaning process is complete.

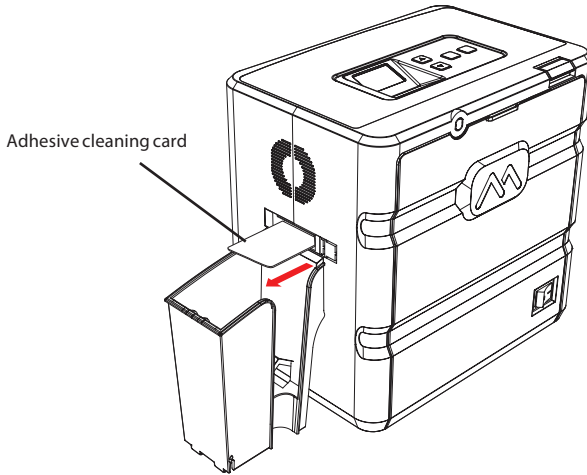

Fire Hazard

Please be sure to use Adhesive cleaning card.
Alcohol type cleaning card may cause fire.

7. Press 'MENU' to go back to the previous step.

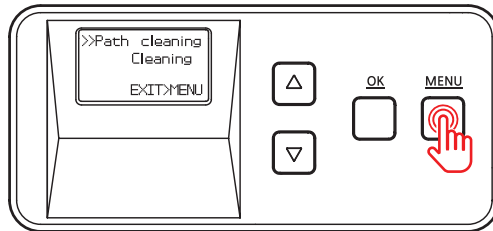

8. Press 'MENU' to go into the standby mode.

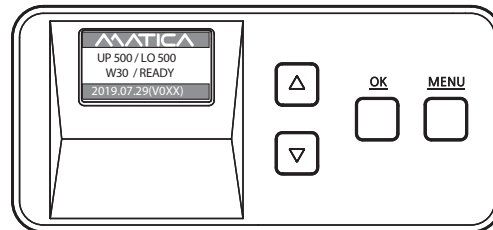
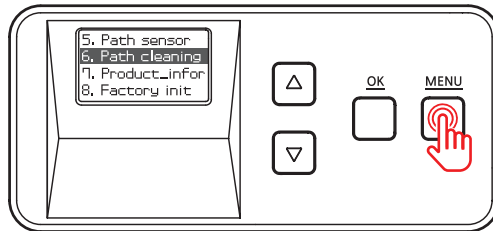

-Clean the Blue Cleaning Roller

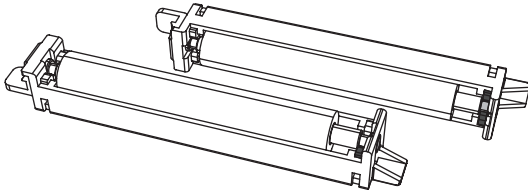

Blue Cleaning Roller

This cleaning tool is designed to remove any unwanted materials from the surface of cards, and it can be used semi-permanently since it can be washed.

It is recommended to clean it at least once every two weeks. If more than 400 cards are laminated within a month, it is recommended to clean it every 200 times of use.

1. Remove the cleaning roller from the laminator
2. Wash it under running water.
3. Make sure that it is fully dried before installing it into the laminator.

Troubleshooting

Some of the problems you may encounter while using the laminator can be fixed by referring to the following troubleshooting guide.

If the problem persists, then please contact your local dealer.

-Error Messages & Solutions

Error Messages	Description	Solution
E11	The temperature of the heater not in use is too high.	Leave the laminator for a while to cool it off. (Power off)
E13	The card loader is empty.	If the error message persists though the cards are loaded, please contact the service representative for assistance.
E20	The Front Cover is open	Check whether the cover is closed properly, If the problem persists, please contact the service representative for assistance.
E21	No cartridge is loaded.	Check the cartridge. If the problem persists, please contact the service representative for assistance.
E22	There is no film. The tag cannot be recognized.	Check if there are films. If there are enough films, check whether the tag can be recognized. If not, please contact the service representative for assistance.
E23	Wrong film	Check whether film is normal, and if there is nothing strange, please contact the service representative for assistance.
E24	The Pass Mode does not match how the cartridge ribbon is loaded. (ex. Pass Mode is set to Both in the menu settings and only the lower cartridge has films.)	Check if film is cut and check PASS MODE setting. If not, please contact the service representative for assistance.
E25	The sensor does not recognize the ribbon mark while lamination is in process.	Check the ribbon mark on the film. If there is no problem with the ribbon mark, please contact the service representative for assistance.
E26	Jam occurs when there is no lamination process.	If there is no card inside the laminator or slot, the system goes back to normal. If the problem persists, please contact the service representative for assistance.
E27	Can't read ribbon	Check if the film is loaded in the correct way. Especially the position of film RFID tag on the film. If there is nothing wrong, please contact the service representative for assistance.
E31	Jam occurs during the lamination process	Turn off the power, remove the cartridge and eject the card rotating knob on the backside. If the problem persists, please contact the service representative for assistance.

Error Messages	Description	Solution
E41	The Sensor does not recognize the mark on the film when starts lamination process.	Please contact the service representative promptly to avoid injuries. (If this occurs when 'Initial', do not try more than twice.)
E42	The heater module fails to return to its original position.	If the error message persists though the cards are loaded, please contact the service representative for assistance.
W10	Film near to end Warning : when the reaming film count is 40 or less.	Prepare the new film and replace the film when the film is ended. The Error code for finished film is E22.
W11	Cleaning Warning :When the reaming film counts are to 40 cards or less and laminated cards count is over 500 times after the last cleaning.	Clean the inside of laminator refer to page 63. 'Clean Roller Using Cleaning card' and prepare to replace the film.
W30	Cleaning Warning:when the laminated card count is over 500 times after the last cleaning	Clean the inside of laminator refer to page 63. 'Clean Roller Using Cleaning card' and prepare to replace the film.

-Remove Jammed Card

Error Messages	Description	Solution
E26	Jam occurs when there is no lamination process.	If there is no card inside the laminator or slot, the system goes back to normal. If the problem persists, please contact the service representative for assistance.
E31	Jam occurs during the lamination process	Turn off the power, remove the cartridge and eject the card rotating knob on the backside. If the problem persists, please contact the service representative for assistance.

1. Turn the power off.

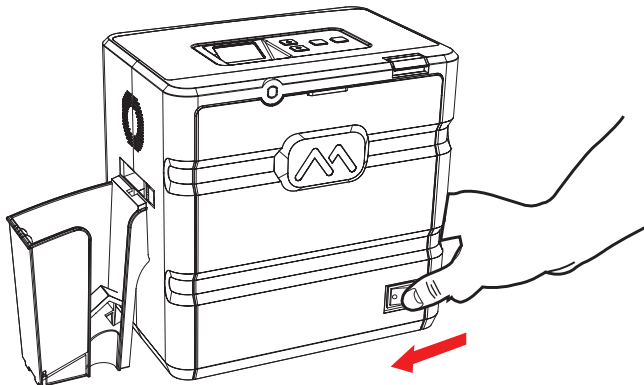

2. Rotate the knob and remove the jammed card as shown in the image.

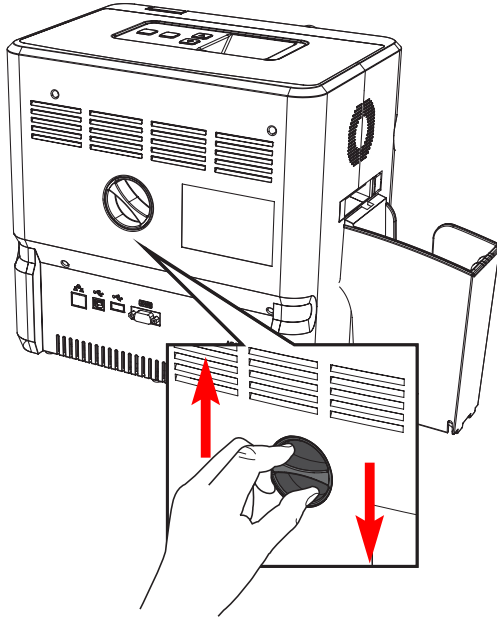

Film Specifications

-Lamination Film Types

Type	Specifications
Clear Patch (0.5 and 1.0mil)	500 Prints/Roll
Generic Hologram Patch (0.5 and 1.0 mil)	500 Prints/Roll
Customized Hologram Patch (0.5 and 1.0 mil)	500 Prints/Roll
Clear Overlay	1,000 Prints/Roll
Generic Hologram Overlay	1,000 Prints/Roll
Customized Hologram Overlay	1,000 Prints/Roll

Laminator Specifications

-Features

Quick heating process and laminating performance

- After initialization, the system is ready within 40 seconds and laminates both sides within 20 seconds.

Easy operation and configuration

- Easy to operate and configure the quality settings

- Easy to load the film cartridge thanks to door-type front cover

- Designed with a knob for removing jammed card

- Wide display and convenient button control
(4Line MONO LCD, 4 Control Buttons)

High level of security

- The front cover can be locked to protect the films inside (optional feature).

High capacity of laminator films

- Up to 500 laminator films (Dual sides) are supported.

Various types of card supportive

- CR-80 card stock

-Standard Specifications

① Laminating Type

- Heat Roller + Halogen Lamp Type

② Laminating Function

- Edge to edge, Dual/single sided lamination

③ Laminating Speed

- 8mm/s (for both Dual and single sided lamination)

④ Laminating Temperature

- 120 ~ 185 (248 ~ 365)

⑤ Operating Temperature

- 0 to 40 (0 to 104)

⑥ Supported Card Size

- CR-80(Default)

⑦ Film Patch Dimensions

- Size:83mm x 52mm
- Thickness:0.5mil or 1.0mil

⑧ Film Patch Capacity

- 500 patches/roll

-Optional Specifications

- Card Stacker: 150 cards (0.76mm)
- Front Cover Lock (for the protection of films)
- Cradle (for connection with a direct card printer/ retransfer card printer)

-Laminator Specifications

① Product Dimensions(Width x Length x Height) and Weight

1) MC-L2 (Standard)

- Dimensions: 216.5mm(W) x 320mm(L) x 313.5mm(H)
- Weight: 9.45kg

2) MC-L2 (Standard, Card Stacker)

- Dimensions: 216.5mm(W) x 443.4mm(L) x 313.5mm(H)
- Weight: 9.65kg

② Power Supply

- AC 100-240Vac, 50/60Hz, 10A
- Single 600W/ Dual 600W

③ Interface

- USB2.0
- RS-232

